

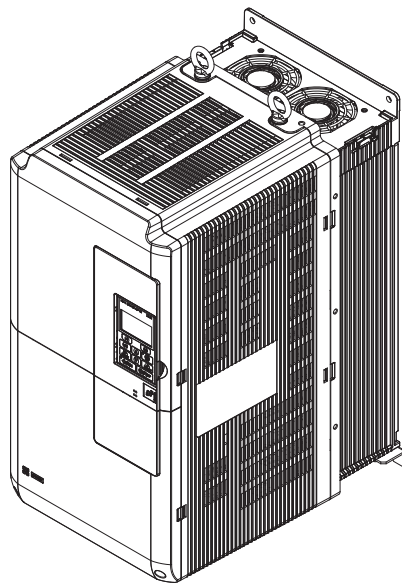
Low Harmonic Drive for HVAC Applications Z1000U HVAC MATRIX Drive Quick Start Guide

Type: CIMR-ZU

Models: 200 V Class: 7.5 to 75 kW (10 to 100 HP ND)

400 V Class: 5.5 to 260 kW (7.5 to 350 HP ND)

To properly use the product, read this manual thoroughly and retain for easy reference, inspection, and maintenance. Ensure the end user receives this manual.



This Page Intentionally Blank

Copyright © 2014 YASKAWA ELECTRIC CORPORATION. All rights reserved.

No part of this publication may be reproduced, stored in a retrieval system, or transmitted, in any form or by any means, mechanical, electronic, photocopying, recording, or otherwise, without the prior written permission of Yaskawa. No patent liability is assumed with respect to the use of the information contained herein. Moreover, because Yaskawa is constantly striving to improve its high-quality products, the information contained in this manual is subject to change without notice. Every precaution has been taken in the preparation of this manual. Yaskawa assumes no responsibility for errors or omissions. Neither is any liability assumed for damages resulting from the use of the information contained in this publication.

Z1000U HVAC MATRIX Quick Start Guide

i.1	PREFACE.....	4
i.2	RECEIVING.....	13
i.3	MECHANICAL INSTALLATION.....	15
i.4	ELECTRICAL INSTALLATION.....	19
i.5	START-UP PROGRAMMING AND OPERATION.....	45
i.6	TROUBLESHOOTING.....	63
i.7	DRIVE SPECIFICATIONS.....	70
i.8	PARAMETER TABLE.....	72
i.9	STANDARDS COMPLIANCE.....	80

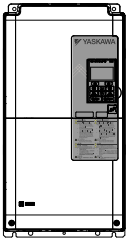
i.1 Preface

Yaskawa manufactures products used as components in a wide variety of industrial systems and equipment. The selection and application of Yaskawa products remain the responsibility of the equipment manufacturer or end user. Yaskawa accepts no responsibility for the way its products are incorporated into the final system design. Without exception, all controls should be designed to detect faults dynamically and fail safely under all circumstances. All systems or equipment designed to incorporate a product manufactured by Yaskawa must be supplied to the end user with appropriate warnings and instructions as to the safe use and operation of that part. Any warnings provided by Yaskawa must be promptly provided to the end user. Yaskawa offers an express warranty only as to the quality of its products in conforming to standards and specifications published in the Yaskawa manual. **NO OTHER WARRANTY, EXPRESS OR IMPLIED, IS OFFERED.** Yaskawa assumes no liability for any personal injury, property damage, losses, or claims arising from misapplication of its products.

This manual is designed to ensure correct and suitable application of Z1000U-Series Drives. Read this manual before attempting to install, operate, maintain, or inspect a drive and keep it in a safe, convenient location for future reference. Be sure you understand all precautions and safety information before attempting application.

◆ Applicable Documentation

The following manuals are available for Z1000U-series drives:

	Z1000U HVAC MATRIX Drive Quick Start Guide TOEPC71063611
	Read this guide first. This guide is packaged together with the product and contains basic information required to install and wire the drive. It also gives an overview of fault diagnostics, maintenance safety, and parameter settings. The most recent version of this manual is available for download on our documentation website, www.yaskawa.com .
	Z1000U HVAC MATRIX Drive User Manual TOEPC71063610
	This manual contains detailed information on fault diagnostics, parameter settings, and BACnet specifications. The most recent version of this manual is available for download on our documentation website, www.yaskawa.com .
	Z1000U HVAC MATRIX Drive Programming Manual SIEPC71063610
	This manual provides detailed information on parameter settings, drive functions, and MEMOBUS/Modbus specifications. Use this manual to expand drive functionality and to take advantage of higher performance features. The most recent version of this manual is available for download on our documentation website, www.yaskawa.com .

◆ Supplemental Safety Information

General Precautions

- The diagrams in this manual may be indicated without covers or safety shields to show details. Replace the covers or shields before operating the drive and run the drive according to the instructions described in this manual.
- Any illustrations, photographs, or examples used in this manual are provided as examples only and may not apply to all products to which this manual is applicable.
- The products and specifications described in this manual or the content and presentation of the manual may be changed without notice to improve the product and/or the manual.
- When ordering a new copy of the manual due to damage or loss, contact Yaskawa or a Yaskawa representative and provide the manual number shown on the front cover.
- If nameplate becomes worn or damaged, order a replacement from Yaskawa or a Yaskawa representative.

⚠ WARNING

Read and understand this manual before installing, operating or servicing this drive. The drive must be installed according to this manual and local codes.

The following conventions are used to indicate safety messages in this manual. Failure to heed these messages could result in serious or fatal injury or damage to the products or to related equipment and systems.

⚠ DANGER

Indicates a hazardous situation, which, if not avoided, will result in death or serious injury.

⚠ WARNING

Indicates a hazardous situation, which, if not avoided, could result in death or serious injury.

WARNING! may also be indicated by a bold key word embedded in the text followed by an italicized safety message.

⚠ CAUTION

Indicates a hazardous situation, which, if not avoided, could result in minor or moderate injury.

CAUTION! may also be indicated by a bold key word embedded in the text followed by an italicized safety message.

NOTICE

Indicates a property damage message.

NOTICE: may also be indicated by a bold key word embedded in the text followed by an italicized safety message.

◆ Safety Messages**⚠ DANGER**

Heed the safety messages in this manual.

Failure to comply will result in death or serious injury.

The operating company is responsible for any injuries or equipment damage resulting from failure to heed the warnings in this manual.

Electrical Shock Hazard

Before servicing, disconnect all power to the equipment.

The output terminals remain charged even after the power supply is turned off. The charge indicator LED will extinguish when the control circuit DC voltage is below 50 Vdc. To prevent electric shock, wait for at least the time specified on the warning label, once all indicators are OFF, measure for unsafe voltages to confirm the drive is safe prior to servicing.

Failure to comply will result in death or serious injury.

⚠ WARNING**Sudden Movement Hazard**

System may start unexpectedly upon application of power, resulting in death or serious injury.

Clear all personnel from the drive, motor and machine area before applying power. Secure covers, couplings, shaft keys and machine loads before applying power to the drive.

Arc Flash Hazard

It is possible that there is more than one source of power for the equipment.

Obey the requirements for Electrical Safety in the Workplace and local codes for safe work procedures and applicable personal protective equipment (PPE).

Failure to obey can cause serious injury or death.

Electrical Shock Hazard

Do not attempt to modify or alter the drive in any way not explained in this manual.

Failure to comply could result in death or serious injury.

Yaskawa is not responsible for any modification of the product made by the user. This product must not be modified.

⚠ WARNING

Do not allow unqualified personnel to use equipment.

Failure to comply could result in death or serious injury.

Installation, maintenance, inspection, and service must be performed only by authorized personnel familiar with installation, adjustment and maintenance of AC drives.

Do not remove covers or touch circuit boards while the power is on.

Failure to comply could result in death or serious injury.

Make sure the protective earthing conductor complies with technical standards and local safety regulations.

Because the leakage current exceeds 3.5 mA in models 4□0302 and larger, IEC/EN 61800-5-1:2007 states that either the power supply must be automatically disconnected in case of discontinuity of the protective earthing conductor or a protective earthing conductor with a cross-section of at least 10 mm² (Cu) or 16 mm² (Al) must be used. Failure to comply may result in death or serious injury.

Always use appropriate equipment for Ground Fault Circuit Interrupters (GFCIs).

The drive can cause a residual current with a DC component in the protective earthing conductor. Where a residual current operated protective or monitoring device is used for protection in case of direct or indirect contact, always use a type B GFCI according to IEC/EN 60755.

Fire Hazard

Do not use an improper voltage source.

Failure to comply could result in death or serious injury by fire. Verify that the rated voltage of the drive matches the voltage of the incoming power supply before applying power.

Do not use improper combustible materials.

Failure to comply could result in death or serious injury by fire. Attach the drive to metal or other noncombustible material.

Tighten all terminal screws to the specified tightening torque.

Loose electrical connections could result in death or serious injury by fire due to overheating of electrical connections.

Install adequate branch circuit protection according to applicable local codes and this manual. Failure to comply could result in fire and damage to the drive or injury to personnel.

The device is suitable for use on a circuit capable of delivering not more than 100,000 RMS symmetrical amperes, 240 Vac maximum (200 V class), 480 Vac maximum (400 V class: 4E□□□□ and 4W□□□□), and 500 Vac maximum (400 V class: 4U□□□□ and 4P□□□□) when protected by branch circuit protection devices specified in this document.

Crush Hazard

Do not use this drive in lifting applications without installing external safety circuitry to prevent accidental dropping of the load. The drive does not possess built-in load drop protection for lifting applications.

Failure to comply could result in death or serious injury from falling loads.

Install electrical and/or mechanical safety circuit mechanisms independent of drive circuitry.

⚠ CAUTION

Crush Hazard

Do not carry the drive by the front cover.

Failure to comply may result in minor or moderate injury from the main body of the drive falling.

NOTICE

Observe proper electrostatic discharge procedures (ESD) when handling the drive and circuit boards. Failure to comply may result in ESD damage to the drive circuitry.

Do not perform a withstand voltage test or megger test on any part of the drive.

Failure to comply could result in damage to the sensitive devices within the drive.

Do not operate damaged equipment.

Failure to comply could result in further damage to the equipment. Do not connect or operate any equipment with visible damage or missing parts.

If a fuse is blown or a Ground Fault Circuit Interrupter (GFCI) is tripped, check the wiring and the selection of the peripheral devices.

Check for short circuits or ground faults on the secondary side of fuses and GFCIs and check the wiring and the selection of peripheral devices. Remove the cause of the problem and then turn the power supply off and on again. If the cause cannot be identified, do not turn on the power supply or attempt to operate the equipment.

Do not restart the drive immediately operate the peripheral devices if a fuse is blown or a GFCI is tripped.

Check the wiring and the selection of peripheral devices to identify the cause. Contact Yaskawa or a Yaskawa representative before restarting the drive or the peripheral devices if the cause cannot be identified.

Do not expose the drive to halogen group disinfectants.

Failure to comply may cause damage to the electrical components in the drive.

Do not pack the drive in wooden materials that have been fumigated or sterilized. Do not sterilize the entire package after the product is packed.

■ General Application Precautions

Selection

Drive Rated Output Current

Make sure that the motor rated current is less than the rated output current for the drive.

When 2 Seconds is Required for Momentary Power Loss Ride-Thru Time

Use the units listed below when continuing drive operation after the power is restored even after a momentary loss of power of 2 seconds occurs:

- 200 V class Momentary Power Loss Ride-Thru unit: Model no. P0010
- 400 V class Momentary Power Loss Ride-Thru unit: Model no. P0020

Drive Start-Up Time

The drive requires 1.5 seconds to prepare for operation after the power is turned on. Be mindful of this delay when using an external reference input.

Note: 1.5 seconds is the required time when no optional devices are used with the drive. When using an optional communication device, the time required for the drive to be ready for operation will vary in accordance with the start up time of the communication card.

Selection of Power Supply Capacity

Use a power supply greater than the rated input capacity (kVA) of the drive. If the power supply is lower than the rated capacity of the drive, the device will be unable to run the application properly and will trigger a fault.

The rated input capacity of the drive, S_{CONV} (kVA), can be calculated by the following formula:

$$S_{CONV} = \sqrt{3} \times I_{in} \times V_{in} / 1000$$

(I_{in} : Rated input current [A], V_{in} : Applicable power supply voltage [V])

Connection to Power Supply

The total impedance of the power supply and wiring for the rated current of the drive is %Z = 10% or more. Power voltage distortion may occur when the impedance of the power supply is too large. When wiring over long distances, be sure to take preventative measures such as using thick cables or series wiring to lower the impedance of wiring. Contact Yaskawa or a Yaskawa representative for details.

i.1 Preface

Grounding the Power Supply

Yaskawa recommends using a dedicated ground for the power supply, as the drive is designed to run with a 1:1 ratio relative to the power supply. Ground other devices as directed in the specifications for those devices. Take particular care when connecting sensitive electronic devices. Separate ground lines and install a noise filter to prevent problems from noise.

When Using a Generator as a Power Supply

Select the generator capacity approximately twice as large as the drive input power supply capacity. Set the deceleration time or load so that the regenerative power from the motor will be 10% or less of the generator capacity. For further information, contact Yaskawa or a Yaskawa representative.

When a Phase Advance Capacitor or Thyristor Controller is Provided for the Power Supply

Do not install a phase advancing capacitor to the drive.

For the phase advance capacitor that has already been installed on the same power supply system as the drive, switch to a phase-advanced capacitor with a series reactor to prevent oscillation with the drive.

Contact Yaskawa or a Yaskawa representative when a device generating voltage surge or voltage distortion such as DC motor drive thyristor controller or magnetic agitator is installed on the same power supply system.

Prevention Against EMC or High Frequency Leakage Current

Use units with built-in EMC filters that have the CE marking.

Use a zero-phase reactor as a noise filter when a device that will be affected by noise is near the drive.

Effects of Power Supply Distortion

Distortion of the power supply voltage increases the harmonics contents due to power supply harmonics entering the drive.

Starting Torque

The startup and acceleration characteristics of the motor are restricted to the drive overload current rating.

The overload rating for the drive determines the starting and accelerating characteristics of the motor. Expect lower torque than when running from line power. To achieve a higher starting torque, use a larger drive or a drive and motor with larger capacity.

Emergency Stop

During a drive fault condition, the output shuts off but the motor does not stop immediately. A mechanical brake may be required when it is necessary to stop the motor faster than the ability of the Fast Stop function of the drive.

Repetitive Starting/Stopping

Laundry machines, punching presses, and other applications with frequent starts and stops often approach 150% of their rated output current values. Heat stress generated from repetitive high current will shorten the life span of the IGBTs. The expected life span of the IGBTs is about 8 million start and stop cycles with a 4 kHz carrier frequency and a 150% peak current.

Run only one motor from each drive when using vector control. It is not possible to run more than one motor from one drive with vector control.

■ Carrier Frequency Derating

Reduce the rated output current of the drive when increasing the carrier frequency above the factory default setting. Refer to the User Manual for details.

Installation

Enclosure Panels

Keep the drive in a clean environment by installing the drive in an enclosure panel or selecting an installation area free of airborne dust, lint, and oil mist. Be sure to leave the required space between drives to provide for cooling, and take proper measures so the ambient temperature remains within allowable limits and keep flammable materials away from the drive. Yaskawa offers protective designs for drives that must be used in areas subjected to oil mist and excessive vibration. Contact Yaskawa or a Yaskawa representative for details.

Installation Direction

NOTICE: *Install the drive upright as specified in the manual. Refer to the Mechanical Installation section for more information on installation. Failure to comply may damage the drive due to improper cooling.*

Settings

Motor Code

When using a permanent magnet motor, set the proper motor code to parameter E5-01 before performing a trial run.

Upper Limits

NOTICE: *The drive is capable of running the motor up to 400 Hz. Be sure to set the upper limit for the frequency of the drive to prevent the possible danger of accidentally operating equipment at higher than rated speed. The default setting for the maximum output frequency is 60 Hz.*

DC Injection Braking

NOTICE: *Excessive current during DC Injection Braking and excessive duration of DC Injection Braking can cause motor overheat.*

Acceleration/Deceleration Times

Acceleration and deceleration times are affected by the amount of torque generated by the motor, the load torque, and the moment of inertia. Set a longer accel/decel time when Stall Prevention is enabled. The accel/decel times are lengthened for as long as the Stall Prevention function is in operation. Install one of the available braking options or increase the capacity of the drive for faster acceleration and deceleration.

General Handling

Wiring Check

NOTICE: *Be sure to perform a final check of all sequence wiring and other connections before turning on the power and also check for short circuits on the control terminals, which may damage the drive.*

Selecting a Circuit Breaker or Circuit Interrupter

Yaskawa recommends installing a Ground Fault Circuit Interrupter (GFCI) to the power supply side. The GFCI should be designed for use with AC drives (e.g., Type B according to IEC/EN 60755).

Select a Molded Case Circuit Breaker (MCCB) or GFCI with a rated current 1.5 to 2 times higher than the drive rated current to avoid nuisance trips caused by harmonics in the drive input current.

Magnetic Contactor Installation

WARNING! *Fire Hazard. Shut off the drive with a magnetic contactor (MC) when a fault occurs in any external equipment such as braking resistors. Failure to comply may cause resistor overheating, fire, and injury to personnel.*

NOTICE: *To get the full performance life out of the electrolytic capacitors and circuit relays, refrain from switching the drive power supply off and on more than once every 30 minutes. Frequent use can damage the drive. Use the drive to stop and start the motor.*

Inspection and Maintenance

WARNING! *Electrical Shock Hazard. Capacitors in the drive do not immediately discharge after shutting off the power. Wait for at least the amount of time specified on the drive before touching any components after shutting off the power. Failure to comply may cause injury to personnel from electrical shock.*

WARNING! *Electrical Shock Hazard. When a drive is running a PM motor, voltage continues to be generated at the motor terminals after the drive is shut off while the motor coasts to stop. Take the precautions described below to prevent shock and injury:*

- *In applications where the machine can still rotate after the drive has fully stopped a load, install a switch to the drive output side to disconnect the motor and the drive.*
- *Do not allow an external force to rotate the motor beyond the maximum allowable speed or to rotate the motor when the drive has been shut off.*
- *Wait for at least the time specified on the warning label after opening the load switch on the output side before inspecting the drive or performing any maintenance.*
- *Do not open and close the load switch while the motor is running.*
- *If the motor is coasting, make sure the power to the drive is turned on and the drive output has completely stopped before closing the load switch.*

WARNING! *Burn Hazard. Because the heatsink can get very hot during operation, take proper precautions to prevent burns. When replacing the cooling fan, shut off the power and wait at least 15 minutes to be sure that the heatsink has cooled down. Failure to comply may cause burn injury to personnel.*

Wiring

WARNING! *Electrical Shock Hazard. Make sure the protective earthing conductor complies with technical standards and local safety regulations. Because the leakage current exceeds 3.5 mA, IEC/EN 61800-5-1:2007 states that either the power supply must be automatically disconnected in case of discontinuity of the protective earthing conductor or a protective earthing conductor with a cross-section of at least 10 mm² (Cu) or 16 mm² (Al) must be used. Failure to comply may cause death or serious injury.*

All wire ends should use ring terminals for UL/cUL compliance. Use only the tools recommended by the terminal manufacturer for crimping.

Transporting the Drive

NOTICE: *Never steam clean the drive. During transport, keep the drive from coming into contact with salts, fluorine, bromine, phthalate ester, and other such harmful chemicals.*

■ Motor Application Precautions

Standard Induction Motors

Low-Speed Range

The cooling fan of a standard motor should sufficiently cool the motor at the rated speed. As the self-cooling capability of such a motor decreases with the speed, applying full torque at low speed will possibly damage the motor. Reduce the load torque as the motor slows to prevent motor damage from overheat. *Figure i.1* shows the allowable load characteristics for a Yaskawa standard motor. Use a motor designed specifically for operation with a drive when 100% continuous torque is needed at low speeds.

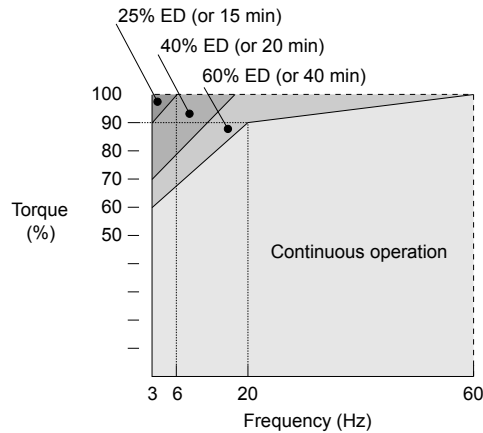


Figure i.1 Allowable Load Characteristics for a Yaskawa Motor

Insulation Tolerance

NOTICE: Consider motor voltage tolerance levels and motor insulation in applications with an input voltage of over 440 V or particularly long wiring distances.

High-Speed Operation

NOTICE: Problems may occur with the motor bearings and dynamic balance of the machine when operating a motor beyond its rated speed. Contact the motor or machine manufacturer.

Torque Characteristics

Torque characteristics differ compared to operating the motor directly from line power. The user should have a full understanding of the load torque characteristics for the application.

Vibration and Shock

The drive allows selection of high carrier PWM control. Selecting Closed Loop Vector control can help reduce motor oscillation.

- Take particular caution when adding a variable speed drive to an application running a motor from line power at a constant speed. If resonance occurs, install shock-absorbing rubber around the base of the motor and enable the Jump Frequency function to prevent continuous operation in the resonant frequency range.
- Mechanical resonance can occur with long motor shafts and in applications such as turbines, blowers, and fans with high inertia loads.

Audible Noise

The audible noise of the motor varies based on the carrier frequency setting. However, drive current derating may be required. When using a high carrier frequency, audible noise from the motor is comparable to the motor noise generated when running from line power.

Synchronous Motors

- Contact Yaskawa or a Yaskawa representative when planning to use a synchronous motor not endorsed by Yaskawa.
- Use a standard induction motor when running multiple synchronous motors simultaneously. A single drive does not have this capability.
- A synchronous motor may rotate slightly in the opposite direction of the Run command at start depending on parameter settings and rotor position.
- The amount of generated starting torque differs depending on the control mode and motor type. Set up the motor with the drive after verifying the starting torque, allowable load characteristics, impact load tolerance, and speed control range.

Contact Yaskawa or a Yaskawa representative when planning to use a motor that does not fall within these specifications:

- In Open Loop Vector Control for PM motors, the allowable load inertia is approximately 50 times higher than the motor inertia.
Contact Yaskawa or a Yaskawa representative for questions concerning applications with larger inertia.
- When using a holding brake in Open Loop Vector Control for PM motors, release the brake prior to starting the motor. Failure to set the proper timing can cause speed loss.
- Use the Speed Search function to restart a coasting motor rotating over 200 Hz while in V/f Control.

Specialized Motors**Multi-Pole Motor**

The rated current of a multi-pole motor differs from that of a standard motor, so be sure to check the maximum current when selecting a drive. Always stop the motor before switching between the number of motor poles. The motor will coast to stop if a regenerative overvoltage (ov) fault occurs or if overcurrent (oC) protection is triggered.

Submersible Motor

The rated current of a submersible motor is greater than that of a standard motor, so select the drive accordingly. Use a motor cable large enough to avoid decreasing the maximum torque level from voltage drop caused by a long motor cable.

Explosion-Proof Motor

The motor and the drive must be tested together to be certified as explosion-proof. The drive is not designed for explosion-proof areas.

When attaching an encoder to an explosion-proof motor, make sure the encoder is also explosion-proof. Use an insulating signal converter to connect the encoder signal lines to the speed feedback option card.

Geared Motor

Make sure that the gear and the lubricant are rated for the desired speed range to avoid gear damage when operating at low speeds or very high speeds. Consult with the manufacturer for applications that require operation outside the rated speed range of the motor or gear box.

Single-Phase Motor

Variable speed drives are not designed to operate with single phase motors. Using capacitors to start the motor causes a high-frequency current to flow to the capacitors and can damage the capacitors. A split-phase start or a repulsion start can burn out the starter coils because the internal centrifugal switch is not activated. The drive is for use with three-phase motors only.

Motor with Brake

Take caution when using the drive to operate a motor with a built-in holding brake. If the brake is connected to the output side of the drive, it may not release at start due to low voltage levels, so be sure to install a separate power supply for the motor brake. Note that motors with built-in brakes tend to generate a fair amount of noise when running at low speeds.

Notes on Power Transmission Machinery

Installing an AC drive in machinery that was previously connected directly to the power supply will allow the machine to operate at variable speeds. Continuous operation outside of the rated speeds can wear out lubrication material in gear boxes and other power transmission parts. Make sure that lubrication is sufficient within the entire speed range to avoid machine damage. Note that operation above the rated speed can increase the noise generated by the machine.

◆ Drive Label Warning Example

Always heed the warning information listed in *Figure i.2*.

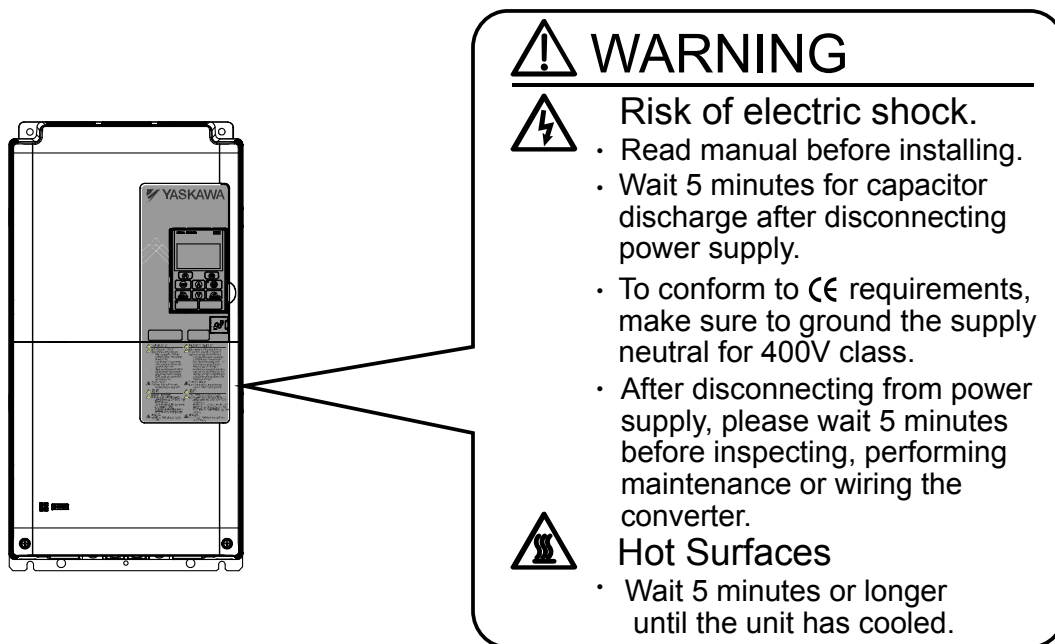


Figure i.2 Warning Information Example and Position

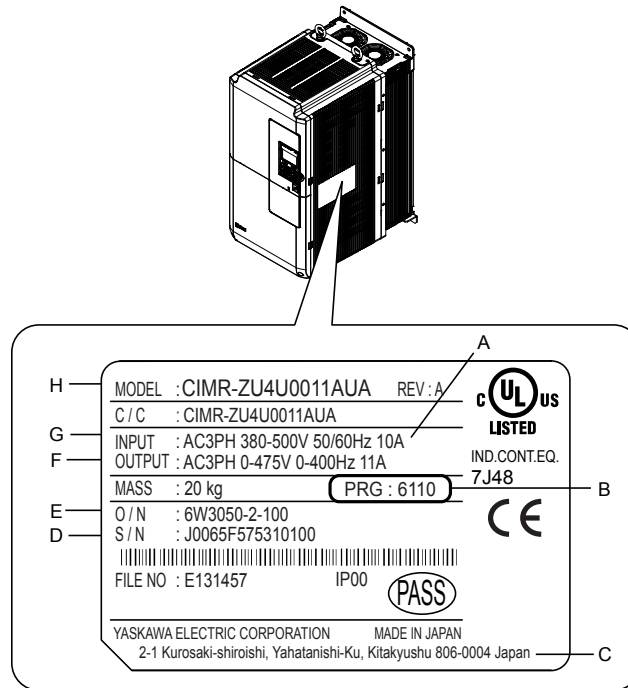
i.2 Receiving

◆ Model Number and Nameplate Check

Please perform the following tasks after receiving the drive:

- Inspect the drive for damage.
If the drive appears damaged upon receipt, contact the shipper immediately.
- Verify receipt of the correct model by checking the information on the nameplate.
- If you have received the wrong model or the drive does not function properly, contact your supplier.

◆ Nameplate



A – Rated Output Current

B – Software version

C – Address <1>

D – Serial number

E – Lot number

F – Output specifications

G – Input specifications

H – AC drive model

Refer to [Figure i.4](#) for details.

Figure i.3 Drive Nameplate Information Example

<1> The address of the head office of Yaskawa Electric Corporation (responsible for product liability) is shown on the nameplate.

◆ Model Number

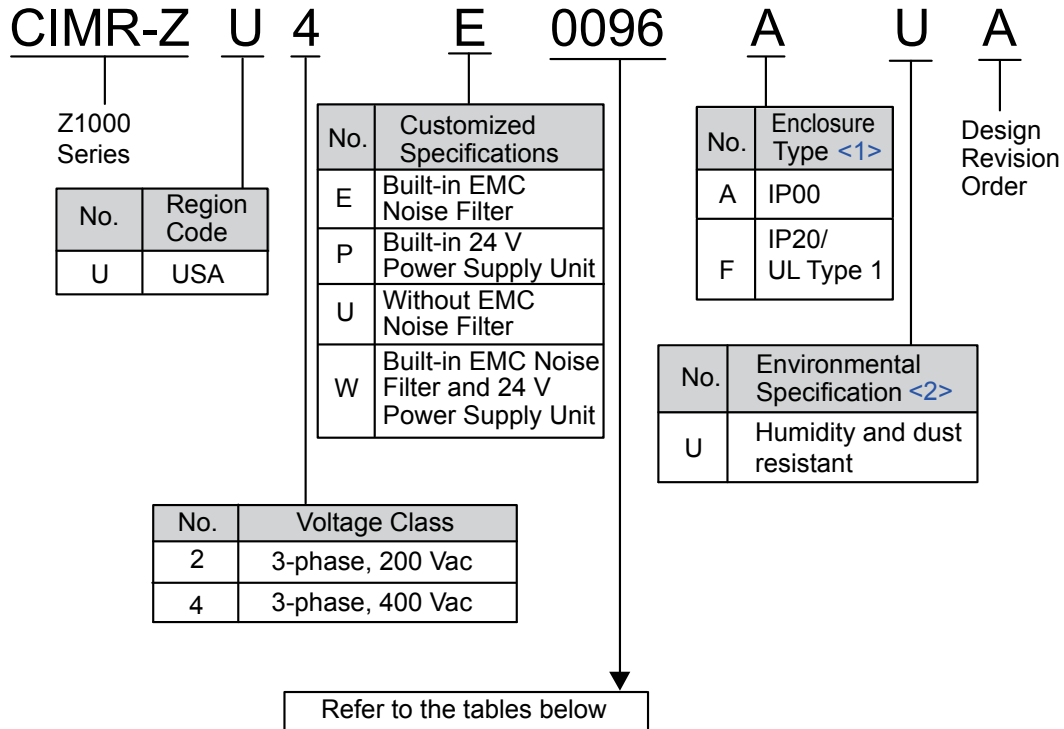


Figure i.4 Drive Model Number Definition

<1> IP20/UL Type 1 enclosure drives require a UL Type 1 kit. Removing the top protective cover from an IP20/UL Type 1 enclosure drive may convert the drive to IP20 conformity.

<2> Drives with these specifications do not guarantee complete protection for the environmental conditions indicated.

■ Three-Phase 200 V Class

Table i.1 Model Number and Specifications (200 V Class)

Drive Model	Reference Motor Capacity kW (HP)	Rated Output Current A	Drive Model	Reference Motor Capacity kW (HP)	Rated Output Current A
2□0028	7.5 (10)	28	2□0104	30 (40)	104
2□0042	11 (15)	42	2□0130	37 (50)	130
2□0054	15 (20)	54	2□0154	45 (60)	154
2□0068	18.5 (25)	68	2□0192	55 (75)	192
2□0081	22 (30)	81	2□0248	75 (100)	248

■ Three-Phase 400 V Class

Table i.2 Model Number and Specifications (400 V Class)

Drive Model	Reference Motor Capacity kW (HP)	Rated Output Current A	Drive Model	Reference Motor Capacity kW (HP)	Rated Output Current A
4□0011	5.5 (7.5)	11	4□0096	55 (75)	96
4□0014	7.5 (10)	14	4□0124	75 (100)	124
4□0021	11 (15)	21	4□0156	90 (125)	156
4□0027	15 (20)	27	4□0180	110 (150)	180
4□0034	18.5 (25)	34	4□0216	132 (175)	216
4□0040	22 (30)	40	4□0240	150 (200)	240
4□0052	30 (40)	52	4□0302	185 (250)	302
4□0065	37 (50)	65	4□0361	220 (300)	361
4□0077	45 (60)	77	4□0414	260 (350)	414

i.3 Mechanical Installation

This section outlines specifications, procedures, and the environment for proper mechanical installation of the drive.

◆ Installation Environment

Install the drive in an environment matching the specifications in [Table i.3](#) to help prolong optimum performance life.

Table i.3 Drive Installation Environment

Environment	Conditions
Installation Area	Indoors
Ambient Temperature	IP00/Open Type enclosure: -10 °C to +50 °C (14 °F to 122 °F) IP20/UL Type 1 enclosure: -10 °C to +40 °C (14 °F to 104 °F) Drive reliability improves in environments without wide temperature fluctuations. When using the drive in an enclosure panel, install a cooling fan or air conditioner in the area to ensure that the air temperature inside the enclosure does not exceed the specified levels. Do not allow ice to develop on the drive.
Humidity	95% RH or less and free of condensation
Storage Temperature	-20 °C to +60 °C (-4 °F to +104 °F)
Surrounding Area	Install the drive in an area free from: <ul style="list-style-type: none"> • oil mist and dust • metal shavings, oil, water, or other foreign materials • radioactive materials • combustible materials (e.g., wood) • harmful gases and liquids • excessive vibration • chlorides • direct sunlight.
Altitude	1000 m (3281 ft.) or lower, up to 3000 m (9843 ft.) with derating
Vibration	10 to 20 Hz: 9.8 m/s ² (2□0028 to 2□0248, 4□0011 to 4□0414) 20 to 55 Hz: 5.9 m/s ² (2□0028 to 2□0081, 4□0011 to 4□0077) 20 to 55 Hz: 2.0 m/s ² (2□0104 to 2□0248, 4□0096 to 4□0414)
Orientation	Install the drive vertically to maintain maximum cooling effects.

NOTICE: Avoid placing peripheral devices, transformers, or other electronics near the drive, as the noise created can lead to erroneous operation. Take proper steps to shield the drive from noise if such devices must be used in close proximity.

NOTICE: Prevent foreign matter such as metal shavings and wire clippings from falling into the drive during installation. Failure to comply could result in damage to the drive. Place a temporary cover over the top of the drive during installation. Remove the temporary cover before start-up, as the cover will reduce ventilation and cause overheat.

◆ Installation Orientation and Spacing

NOTICE: Install the drive upright as illustrated in [Figure i.5](#). Failure to comply may damage the drive due to improper cooling.

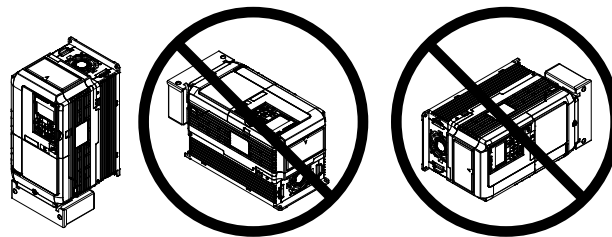


Figure i.5 Correct Installation Orientation

NOTICE: Install the drive upright as specified in the manual. Failure to comply may damage the drive due to improper cooling.

■ Single Drive Installation

[Figure i.6](#) shows the installation distance required to maintain sufficient space for airflow and wiring.

i.3 Mechanical Installation

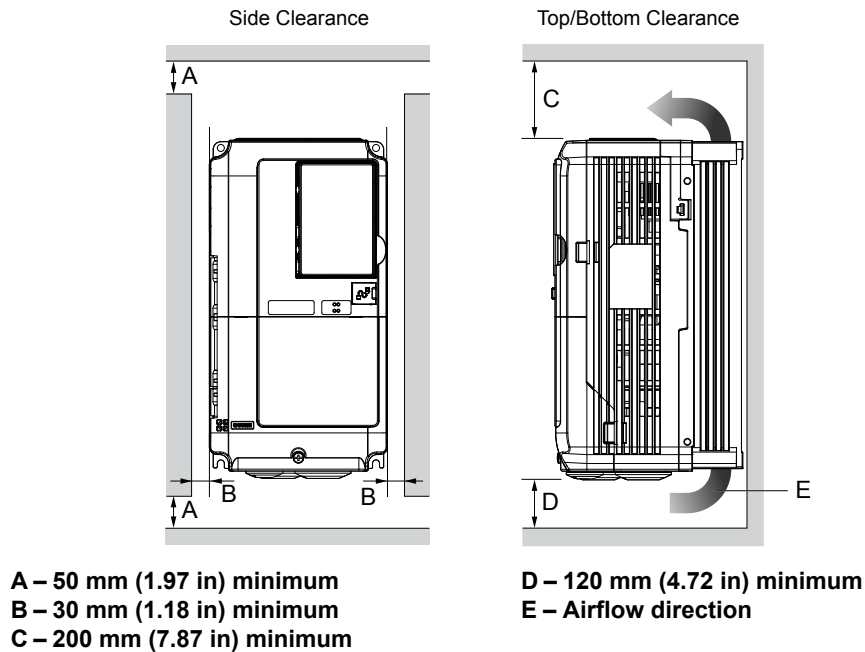


Figure i.6 Correct Drive Installation Spacing

Note: IP20/UL Type 1 enclosure and IP00/Open Type enclosure models require the same amount of space above and below the drive for installation.

◆ Instructions on Installation Using the Eye Bolts and Hanging Brackets

Eye bolts and hanging brackets are used to install the drive or to temporarily lift the drive during drive replacement. Using the eye bolts and hanging brackets, the drive can be installed in an enclosure panel or on a wall. Do not leave the drive suspended by the wires in a horizontal or vertical position for long periods of time. Do not transport the drive over long distances. Read the following precautions and instructions before installing the drive.

WARNING! Crush Hazard. Observe the following instructions and precautions. Failure to comply could result in serious injury or death from falling equipment.

Only use vertical suspension to temporarily lift the drive during installation to an enclosure panel. Do not use vertical suspension to transport the drive.

Confirm that the spring washer is completely closed prior to lifting to prevent damage to the drive.

Use screws to securely affix the drive front cover, terminal blocks, and other drive components prior to vertical suspension.

Do not subject the drive to vibration or impact greater than 1.96 m/s^2 (0.2 G) while it is suspended by the wires.

Do not leave the drive unattended while it is suspended by the wires.

Do not attempt to flip the drive over while it is suspended by the wires.

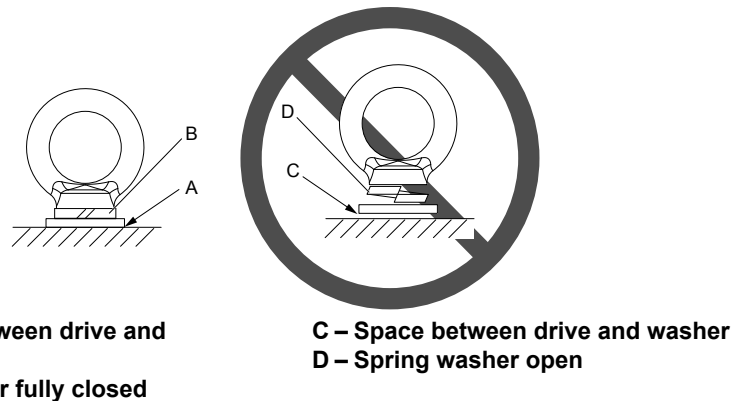


Figure i.7 Spring Washer

■ Horizontal Suspension of Drive Models 2□0154 to 2□0248, 4□0156 to 4□0414

To make a wire hanger or frame for use when lifting the drive with a crane, lay the drive in a horizontal position and pass a wire through the hanging brackets.

NOTICE: Use the hanging brackets on the top and hanging holes of the bottom cover when lifting drive models 2□0154F, 2□0192F, 4□0156F, and 4□0180F.

2□0154A, 2□0192A, 2□0248,

2□0154F, 2□0192F, 4□0156F, and 4□0180F

4□0156A, 4□0180A, and 4□0216 to 4□0414

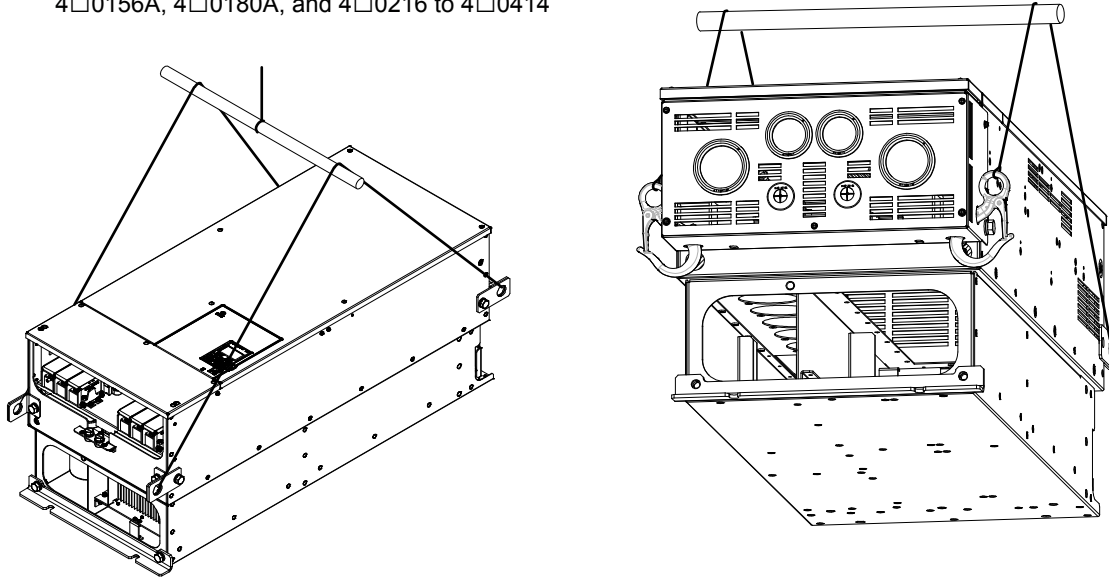


Figure i.8 Horizontal Suspension of Drive Model 2□0154

■ Vertical Suspension of the Drive

Follow the procedure described below when suspending the drive with eye bolts or hanging brackets.

Drive Models 2□0028 to 2□0130 and 4□0011 to 4□0124

WARNING! Crush Hazard. Use an adequate length of wire to ensure a 50° or wider suspension angle as illustrated in [Figure i.9](#). The maximum allowable load of the eye bolts cannot be guaranteed when the drive is suspended with the wires at angles less than 50°. Failure to comply may result in serious injury or death from falling equipment.

1. Pass wire through the holes of the two eye bolts.

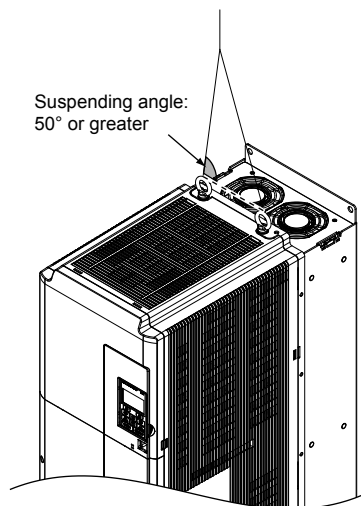


Figure i.9 Suspension Using Wires and Eye Bolts

2. Gradually take up the slack in the wires and hoist the drive after the wires are stretched tight.
3. Lower the drive when ready to install in the enclosure panel. Stop lowering when near the floor, then slowly begin lowering the drive again until the drive is placed correctly.

i.3 Mechanical Installation

Drive Models 2□0154 to 2□0248 and 4□0156 to 4□0414

WARNING! Crush Hazard. Use an adequate length of wire to ensure a 50° or wider suspension angle as illustrated in [Figure i.10](#). The maximum allowable load of the eye bolts cannot be guaranteed when the drive is suspended with the wires at angles less than 50°. Failure to comply may result in serious injury or death from falling equipment.

1. Remove the two hanging brackets from the drive lower side panels and bolt them on the top panel.

- Note:**
1. Tighten the hanging brackets with the specified tightening torque: M10: 18 to 23 N·m (159 to 204 in-lb), M12: 32 to 40 N·m (283 to 354 in-lb).
 2. Four hanging brackets are attached to the top of IP20/UL Type 1 drives 2□0154F, 2□0192F, 4□0156F, and 4□0180F.

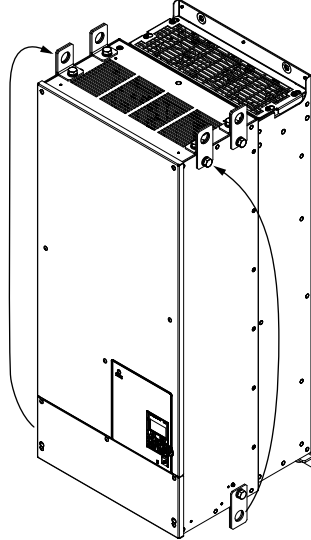


Figure i.10 Location of Hanging Brackets (Drive Models 2□0154 to 2□0248 and 4□0156 to 4□0414)

2. Pass wire through the holes of all four hanging brackets.

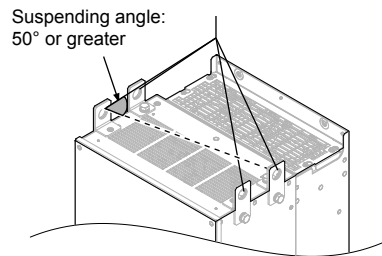


Figure i.11 Drive Suspension Using Wires and Hanging Brackets
(Drive Models 2□0154 to 2□0248 and 4□0156 to 4□0414)

3. Gradually take up the slack in the wires and hoist the drive after the wires are stretched tight.
4. Lower the drive when ready to install in the enclosure panel. Stop lowering the drive when it is near the floor, then slowly begin lowering the drive again until the drive is placed correctly.

◆ Drive Dimensions

NOTICE

Refer to the Z1000U HVAC MATRIX Drive User Manual TOEP C710636 10 for IP20/UL Type 1 and IP00/Open Chassis dimensions.

The Z1000U HVAC MATRIX Drive User Manual is posted on the Yaskawa website, www.yaskawa.com.

i.4 Electrical Installation

◆ Standard Connection Diagram

Connect the drive and peripheral devices as shown in [Figure i.12](#). It is possible to set and run the drive via the HOA keypad without connecting digital I/O wiring.

WARNING! Sudden Movement Hazard. Do not close the wiring for the control circuit unless the multifunction input terminal parameters are properly set. Improper sequencing of run/stop circuitry could result in death or serious injury from moving equipment.

WARNING! Sudden Movement Hazard. Ensure start/stop and safety circuits are wired properly and in the correct state before energizing the drive. Failure to comply could result in death or serious injury from moving equipment. When programmed for 3-Wire control, a momentary closure on terminal S1 may cause the drive to start.

WARNING! Sudden Movement Hazard. When using a 3-Wire sequence, set the drive to 3-Wire sequence prior to wiring the control terminals and set parameter b1-17 to 0 so the drive will not accept a Run command at power up (default). If the drive is wired for a 3-Wire sequence but set up for a 2-Wire sequence (default), and parameter b1-17 is set to 1 so the drive accepts a Run command at power up, the motor will rotate in reverse direction at drive power up and may cause injury.

WARNING! Sudden Movement Hazard. Confirm the drive I/O signals and external sequence before executing the application preset function. Executing the application preset function or setting A1-06 ≠ 0 will change the drive I/O terminal functions and may cause unexpected equipment operation. Failure to comply may cause death or serious injury.

WARNING! When using the automatic fault restart function with wiring designed to shut off the power supply upon drive fault, make sure the drive does not trigger a fault output during fault restart (L5-02 = 0, default). Failure to comply will prevent the automatic fault restart function from working properly.

NOTICE: Inadequate wiring could result in damage to the drive. Install adequate branch circuit short circuit protection per applicable codes. The drive is suitable for use on a circuit capable of delivering not more than 100,000 RMS symmetrical amperes, 240 Vac maximum (200 V class), 480 Vac maximum (400 V class: 4E□□□□ and 4W□□□□), and 500 Vac maximum (400 V class: 4U□□□□ and 4P□□□□) when protected by branch circuit protection devices specified in this document.

NOTICE: When the input voltage is 440 V or higher or the wiring distance is greater than 100 meters, pay special attention to the motor insulation voltage or use a drive duty motor. Failure to comply could lead to motor insulation breakdown.

NOTICE: Do not connect AC control circuit ground to drive enclosure. Improper drive grounding can cause control circuit malfunction.

NOTICE: Route motor leads U/T1, V/T2, and W/T3 separate from all other leads to reduce possible interference related issues. Failure to comply may result in abnormal operation of drive and nearby equipment.

Note: The minimum load for the relay outputs M1-M2, M3-M4, MD-ME-MF, and MA-MB-MC is 10 mA.

NOTICE: Create a sequence to shut off power on the power supply side by using a fault relay output as shown in the standard connection diagram, or create a sequence that prevents the motor shaft from being turned by an external force. If you continue to input power from a power supply with a large distortion or if an external force causes the motor shaft to continue turning even after an SoH (Snubber Discharge Resistor Overheat) occurs, the snubber resistor may break.

NOTICE: Do not connect more than one multi-function input to one terminal. Improper wiring may result in drive malfunction. Use an external power supply when sharing a terminal with more than one input. Do not use the built-in +24 V power supply.

i.4 Electrical Installation

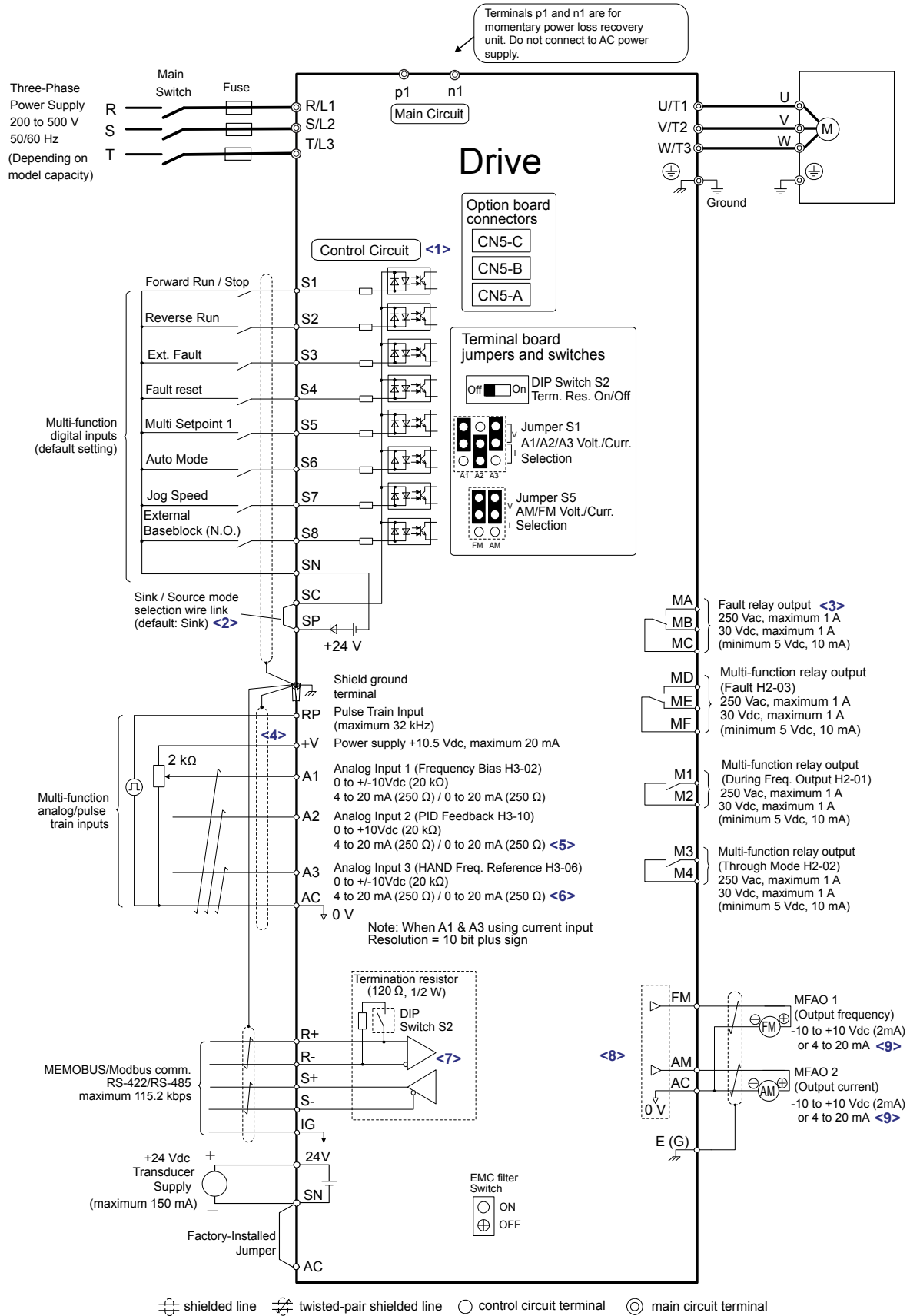


Figure i.12 Drive Standard Connection Diagram (Example: Model 2□0028)

- <1> Supplying power to the control circuit separately from the main circuit requires 24 V power supply (option).
- <2> This figure illustrates an example of a sequence input to S1 through S8 using a non-powered relay or an NPN transistor. Install the wire link between terminals SC-SP for Sink mode, between SC-SN for Source mode, or leave the link out for external power supply. Never short terminals SP and SN, as it will damage the drive. *Missing ID# a--21d9a445-111e6529cd7--5a5b* for details.
- <3> Wire the fault relay output separately from the main circuit power supply and other power lines.
- <4> The maximum output current capacity for the +V terminal on the control circuit is 20 mA. Never short terminals +V or AC, as it can cause erroneous operation or damage the drive.
- <5> Set jumper S1 to select between a voltage or current input signal to terminal A2. The default setting is for current input.
- <6> Set jumper S1 to select between a voltage or current input signal to terminal A1 and A3. The default setting is for current input.
- <7> Set DIP switch S2 to the ON position to enable the termination resistor in the last drive in a MEMOBUS/Modbus network.
- <8> Use jumper S5 to select between voltage or current output signals at terminals AM and FM. Set parameters H4-07 and H4-08 accordingly.
- <9> Monitor outputs work with devices such as analog frequency meters, ammeters, voltmeters, and wattmeters. They are not intended for use as a feedback-type signal.

◆ Main Circuit Connection Diagram

Refer to [Figure i.13](#) when wiring the main circuit of the drive.

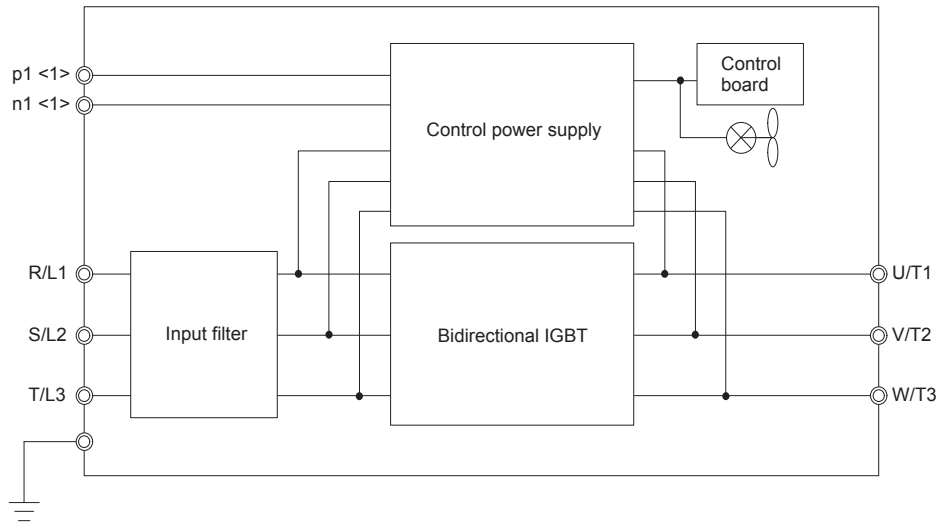


Figure i.13 Connecting Main Circuit Terminals

<1> A Momentary Power Loss Recovery Unit can be connected as an option. Do not connect an AC power supply to these terminals.

◆ Main Circuit Terminal Functions

Table i.4 Main Circuit Terminal Functions

Voltage Class	Three-Phase 200 V Class	Three-Phase 400 V Class	Function	Page
Drive Model	2□0028 to 2□0248	4□0011 to 4□0414		
Terminal	Type			
R/L1, S/L2, T/L3	Main circuit power supply input		Connects line power to the drive	20
U/T1, V/T2, W/T3	Drive output		Connects to the motor	
p1, n1	Momentary power loss recovery unit input		DC voltage terminals that connect to a momentary power loss recovery unit	28
⊕	100 Ω or less	10 Ω or less	Grounding terminal	

◆ Protecting Main Circuit Terminals

■ Insulation Caps or Sleeves

Use insulation caps or sleeves when wiring the drive with crimp terminals. Take particular care to ensure that the wiring does not touch nearby terminals or the surrounding case.

■ Main Circuit Protective Cover

Close the protective cover after wiring the main circuit terminals on drive models 2□0028 to 2□0081 and 4□0011 to 4□0077.

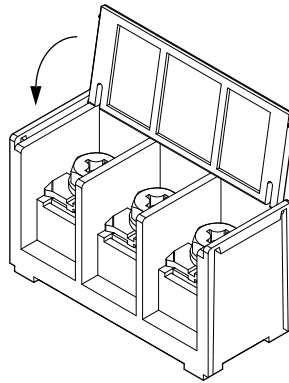
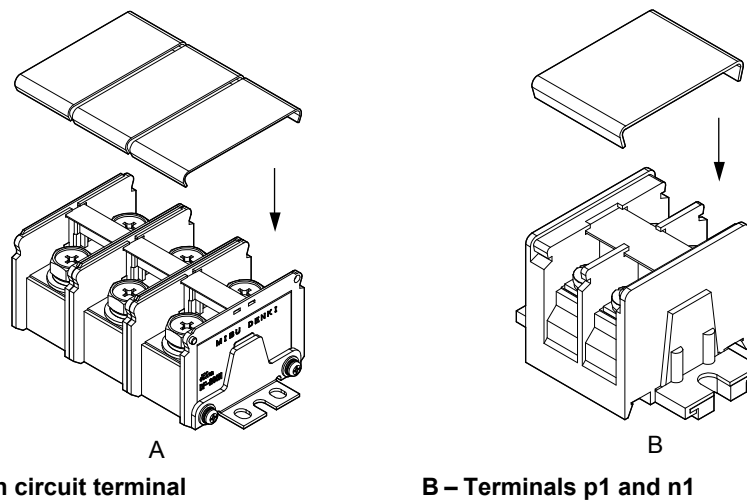


Figure i.14 Main Circuit Protective Cover (Drive Models 2□0028 to 2□0081 and 4□0011 to 4□0077)

Attach the protective covers after wiring the main circuit terminals and p1, and n1 terminals on drive models 2□0104 to 2□0248 and 4□0096 to 4□0414.



A – Main circuit terminal

B – Terminals p1 and n1

Figure i.15 Protective Cover Example (Drive Model 2□0104)

◆ Main Circuit Wire Gauges and Tightening Torque

Use the tables in this section to select the appropriate wires and crimp terminals.

Gauges listed in the tables are for use in the United States.

Note: Wire gauge recommendations based on drive continuous current ratings using 75 °C (167 °F) 600 Vac vinyl-sheathed wire assuming ambient temperature within 40 °C (104 °F) and wiring distance less than 100 m.

Consider the amount of voltage drop when selecting wire gauges. Increase the wire gauge when the voltage drop is greater than 2% of motor rated voltage. Ensure the wire gauge is suitable for the terminal block. Use the following formula to calculate the amount of voltage drop:

$$\text{Line drop voltage (V)} = \sqrt{3} \times \text{wire resistance } (\Omega/\text{km}) \times \text{wire length (m)} \times \text{current (A)} \times 10^{-3}$$

Refer to UL Standards Compliance on page 82 for information on UL compliance.

The wire gauges listed in the following tables are Yaskawa recommendations. Refer to local codes for proper wire gauge selections.

■ Three-Phase 200 V Class Drives

Table i.5 Drive Wire Gauge and Torque Specifications (Three-Phase 200 V Class)

Drive Model	Terminal	For USA and Canada		For South America		Screw Size	Tightening Torque N·m (lb.in.)
		Recomm. Gauge mm ² (AWG, kcmil)	Wire Range mm ² (AWG, kcmil)	Recomm. Gauge mm ² (AWG, kcmil)	Wire Range mm ² (AWG, kcmil)		
2□0028	R/L1, S/L2, T/L3	10 (8)	6 to 10 (10 to 8)	4 (12)	2.5 to 10 (14 to 8)	M5	2.3 to 2.7 (20.4 to 23.9)
	U/T1, V/T2, W/T3	10 (8)	6 to 10 (10 to 8)	4 (12)	2.5 to 10 (14 to 8)	M5	
	⊕	10 (8)	6 to 16 (10 to 6)	6 (10)	6 to 16 (10 to 5)	M6	3.9 to 4.9 (34.7 to 43.4)
	p1, n1	2.5 (14)	2.5 to 4 (14 to 12)	2.5 (14)	2.5 to 4 (14 to 12)	M4	1 to 1.4 (8.9 to 12.4)
2□0042	R/L1, S/L2, T/L3	16 (6)	10 to 25 (8 to 3)	10 (8)	6 to 25 (10 to 3)	M6	4 to 6 (35.4 to 53.1)
	U/T1, V/T2, W/T3	16 (6)	10 to 25 (8 to 3)	10 (8)	6 to 25 (10 to 3)	M6	
	⊕	10 (8)	6 to 25 (10 to 3)	10 (8)	6 to 25 (10 to 3)	M8	8.8 to 10.8 (78.1 to 95.5)
	p1, n1	2.5 (14)	2.5 to 4 (14 to 12)	2.5 (14)	2.5 to 4 (14 to 12)	M4	1 to 1.4 (8.9 to 12.4)
2□0054	R/L1, S/L2, T/L3	25 (4)	16 to 25 (6 to 3)	16 (5)	10 to 25 (8 to 3)	M6	4 to 6 (35.4 to 53.1)
	U/T1, V/T2, W/T3	25 (4)	16 to 25 (6 to 3)	16 (5)	10 to 25 (8 to 3)	M6	
	⊕	16 (6)	10 to 25 (8 to 3)	10 (8)	10 to 25 (8 to 3)	M8	8.8 to 10.8 (78.1 to 95.5)
	p1, n1	2.5 (14)	2.5 to 4 (14 to 12)	2.5 (14)	2.5 to 4 (14 to 12)	M4	1 to 1.4 (8.9 to 12.4)
2□0068	R/L1, S/L2, T/L3	25 (4)	25 (4 to 3)	16 (5)	16 to 25 (5 to 3)	M6	4 to 6 (35.4 to 53.1)
	U/T1, V/T2, W/T3	25 (4)	25 (4 to 3)	16 (5)	16 to 25 (5 to 3)	M6	
	⊕	16 (6)	16 to 25 (6 to 3)	16 (5)	16 to 25 (5 to 3)	M8	8.8 to 10.8 (78.1 to 95.5)
	p1, n1	2.5 (14)	2.5 to 4 (14 to 12)	2.5 (14)	2.5 to 4 (14 to 12)	M4	1 to 1.4 (8.9 to 12.4)
2□0081	R/L1, S/L2, T/L3	16 × 2 (6 × 2P)	16 to 25 × 2 (6 to 3 × 2P)	25 (3)	16 to 25 (5 to 3 × 2P)	M6	4 to 6 (35.4 to 53.1)
	U/T1, V/T2, W/T3	16 × 2 (6 × 2P)	16 to 25 × 2 (6 to 3 × 2P)	25 (3)	16 to 25 (5 to 3 × 2P)	M6	
	⊕	16 (6)	16 to 25 (6 to 3)	16 (5)	16 to 25 (5 to 3)	M8	8.8 to 10.8 (78.1 to 95.5)
	p1, n1	2.5 (14)	2.5 to 4 (14 to 12)	2.5 (14)	2.5 to 4 (14 to 12)	M4	1 to 1.4 (8.9 to 12.4)
2□0104	R/L1, S/L2, T/L3	35 (1)	16 to 50 × 2 (6 to 1/0 × 2P)	35 (1)	10 to 50 × 2P (8 to 1/0 × 2P)	M8	8 to 10 (70.8 to 88.5)
	U/T1, V/T2, W/T3	35 (1)	16 to 50 × 2 (6 to 1/0 × 2P)	35 (1)	10 to 50 × 2P (8 to 1/0 × 2P)	M8	
	⊕	25 (4)	25 to 35 (4 to 1)	25 (3)	10 to 35 (8 to 1)	M8	8.8 to 10.8 (78.1 to 95.5)
	p1, n1	2.5 (14)	2.5 to 4 (14 to 12)	2.5 (14)	2.5 to 4 (14 to 12)	M4	1.2 to 2.0 (10.4 to 17.4)

Drive Model	Terminal	For USA and Canada		For South America		Screw Size	Tightening Torque N·m (lb.in.)
		Recomm. Gauge mm ² (AWG, kcmil)	Wire Range mm ² (AWG, kcmil)	Recomm. Gauge mm ² (AWG, kcmil)	Wire Range mm ² (AWG, kcmil)		
2□0130	R/L1, S/L2, T/L3	25 × 2 (4 × 2P)	16 to 50 × 2 (6 to 1/0 × 2P)	16 × 2P (5 × 2P)	10 to 50 × 2P (8 to 1/0 × 2P)	M8	8 to 10 (70.8 to 88.5)
	U/T1, V/T2, W/T3	25 × 2 (4 × 2P)	16 to 50 × 2 (6 to 1/0 × 2P)	16 × 2P (5 × 2P)	10 to 50 × 2P (8 to 1/0 × 2P)	M8	
	⊖	25 (4)	25 to 35 (4 to 1)	16 (5)	16 to 35 (5 to 1)	M8	8.8 to 10.8 (78.1 to 95.5)
	p1, n1	2.5 (14)	2.5 to 4 (14 to 12)	2.5 (14)	2.5 to 4 (14 to 12)	M4	1.2 to 2.0 (10.4 to 17.4)
2□0154	R/L1, S/L2, T/L3	25 × 2 (3 × 2P)	25 to 95 × 2 (4 to 4/0 × 2P)	25 × 2P (3 × 2P)	16 to 95 × 2P (5 to 4/0 × 2P)	M10	15 to 20 (130 to 173)
	U/T1, V/T2, W/T3	25 × 2 (3 × 2P)	25 to 95 × 2 (4 to 4/0 × 2P)	25 × 2P (3 × 2P)	16 to 95 × 2P (5 to 4/0 × 2P)	M10	
	⊖	25 (4)	25 to 70 (4 to 2/0)	25 (3)	25 to 70 (3 to 2/0)	M10	17.7 to 22.6 (156 to 200)
	p1, n1	2.5 (14)	2.5 to 4 (14 to 12)	2.5 (14)	2.5 to 4 (14 to 12)	M4	1.2 to 2.0 (10.4 to 17.4)
2□0192	R/L1, S/L2, T/L3	35 × 2 (1 × 2P)	25 to 95 × 2 (3 to 4/0 × 2P)	35 × 2P (1 × 2P)	25 to 95 × 2P (3 to 4/0 × 2P)	M10	15 to 20 (130 to 173)
	U/T1, V/T2, W/T3	35 × 2 (1 × 2P)	25 to 95 × 2 (3 to 4/0 × 2P)	35 × 2P (1 × 2P)	25 to 95 × 2P (3 to 4/0 × 2P)	M10	
	⊖	25 (3)	25 to 70 (4 to 2/0)	25 (3)	25 to 70 (3 to 2/0)	M10	17.7 to 22.6 (156 to 200)
	p1, n1	2.5 (14)	2.5 to 4 (14 to 12)	2.5 (14)	2.5 to 4 (14 to 12)	M4	1.2 to 2.0 (10.4 to 17.4)
2□0248	R/L1, S/L2, T/L3	70 × 2 (2/0 × 2P)	35 to 95 × 2 (1 to 4/0 × 2P)	50 × 2P (1/0 × 2P)	35 to 95 × 2P (1 to 4/0 × 2P)	M10	15 to 20 (130 to 173)
	U/T1, V/T2, W/T3	70 × 2 (2/0 × 2P)	35 to 95 × 2 (1 to 4/0 × 2P)	50 × 2P (1/0 × 2P)	35 to 95 × 2P (1 to 4/0 × 2P)	M10	
	⊖	25 (3)	25 to 95 (4 to 4/0)	35 (1)	25 to 95 (3 to 4/0)	M12	31.4 to 39.2 (278 to 347)
	p1, n1	2.5 (14)	2.5 to 4 (14 to 12)	2.5 (14)	2.5 to 4 (14 to 12)	M4	1.2 to 2.0 (10.4 to 17.4)

■ Three-Phase 400 V Class Drives

Table i.6 Drive Wire Gauge and Torque Specifications (Three-Phase 400 V Class)

Drive Model	Terminal	For USA and Canada		For South America		Screw Size	Tightening Torque N·m (lb.in.)
		Recomm. Gauge mm ² (AWG, kcmil)	Wire Range mm ² (AWG, kcmil)	Recomm. Gauge mm ² (AWG, kcmil)	Wire Range mm ² (AWG, kcmil)		
4□0011	R/L1, S/L2, T/L3	2.5 (14)	2.5 to 10 (14 to 8)	2.5 (14)	2.5 to 10 (14 to 8)	M5	2.3 to 2.7 (20.4 to 23.9)
	U/T1, V/T2, W/T3	2.5 (14)	2.5 to 10 (14 to 8)	2.5 (14)	2.5 to 10 (14 to 8)	M5	
	⊖	6 (10)	4 to 16 (12 to 6)	2.5 (14)	2.5 to 16 (14 to 5)	M6	3.9 to 4.9 (34.7 to 43.4)
	p1, n1	2.5 (14)	2.5 to 4 (14 to 12)	2.5 (14)	2.5 to 4 (14 to 12)	M4	1 to 1.4 (8.9 to 12.4)
4□0014	R/L1, S/L2, T/L3	4 (12)	2.5 to 10 (14 to 8)	2.5 (14)	2.5 to 10 (14 to 8)	M5	2.3 to 2.7 (20.4 to 23.9)
	U/T1, V/T2, W/T3	4 (12)	2.5 to 10 (14 to 8)	2.5 (14)	2.5 to 10 (14 to 8)	M5	
	⊖	6 (10)	4 to 16 (12 to 6)	2.5 (14)	2.5 to 16 (14 to 5)	M6	3.9 to 4.9 (34.7 to 43.4)
	p1, n1	2.5 (14)	2.5 to 4 (14 to 12)	2.5 (14)	2.5 to 4 (14 to 12)	M4	1 to 1.4 (8.9 to 12.4)

i.4 Electrical Installation

Drive Model	Terminal	For USA and Canada		For South America		Screw Size	Tightening Torque N·m (lb.in.)
		Recomm. Gauge mm ² (AWG, kcmil)	Wire Range mm ² (AWG, kcmil)	Recomm. Gauge mm ² (AWG, kcmil)	Wire Range mm ² (AWG, kcmil)		
4□0021	R/L1, S/L2, T/L3	6 (10)	4 to 10 (12 to 8)	2.5 (14)	2.5 to 10 (14 to 8)	M5	2.3 to 2.7 (20.4 to 23.9)
	U/T1, V/T2, W/T3	6 (10)	4 to 10 (12 to 8)	2.5 (14)	2.5 to 10 (14 to 8)	M5	
	⊕	6 (10)	4 to 16 (12 to 6)	2.5 (14)	2.5 to 16 (14 to 5)	M6	3.9 to 4.9 (34.7 to 43.4)
	p1, n1	2.5 (14)	2.5 to 4 (14 to 12)	2.5 (14)	2.5 to 4 (14 to 12)	M4	1 to 1.4 (8.9 to 12.4)
4□0027	R/L1, S/L2, T/L3	10 (8)	6 to 10 (10 to 8)	4 (12)	2.5 to 10 (14 to 8)	M5	2.3 to 2.7 (20.4 to 23.9)
	U/T1, V/T2, W/T3	10 (8)	6 to 10 (10 to 8)	4 (12)	2.5 to 10 (14 to 8)	M5	
	⊕	10 (8)	4 to 16 (12 to 6)	4 (12)	4 to 16 (12 to 5)	M6	3.9 to 4.9 (34.7 to 43.4)
	p1, n1	2.5 (14)	2.5 to 4 (14 to 12)	2.5 (14)	2.5 to 4 (14 to 12)	M4	1 to 1.4 (8.9 to 12.4)
4□0034	R/L1, S/L2, T/L3	10 (8)	10 (8)	6 (10)	4 to 10 (12 to 8)	M5	2.3 to 2.7 (20.4 to 23.9)
	U/T1, V/T2, W/T3	10 (8)	10 (8)	6 (10)	4 to 10 (12 to 8)	M5	
	⊕	10 (8)	6 to 16 (10 to 6)	6 (10)	6 to 16 (10 to 5)	M6	3.9 to 4.9 (34.7 to 43.4)
	p1, n1	2.5 (14)	2.5 to 4 (14 to 12)	2.5 (14)	2.5 to 4 (14 to 12)	M4	1 to 1.4 (8.9 to 12.4)
4□0040	R/L1, S/L2, T/L3	10 (8)	10 to 25 (8 to 3)	10 (8)	6 to 25 (10 to 3)	M6	4 to 6 (35.4 to 53.1)
	U/T1, V/T2, W/T3	10 (8)	10 to 25 (8 to 3)	10 (8)	6 to 25 (10 to 3)	M6	
	⊕	10 (8)	10 to 25 (10 to 3)	10 (8)	6 to 25 (10 to 3)	M8	8.8 to 10.8 (78.1 to 95.5)
	p1, n1	2.5 (14)	2.5 to 4 (14 to 12)	2.5 (14)	2.5 to 4 (14 to 12)	M4	1 to 1.4 (8.9 to 12.4)
4□0052	R/L1, S/L2, T/L3	16 (6)	10 to 25 (8 to 3)	10 (8)	10 to 25 (8 to 3)	M6	4 to 6 (35.4 to 53.1)
	U/T1, V/T2, W/T3	16 (6)	10 to 25 (8 to 3)	10 (8)	10 to 25 (8 to 3)	M6	
	⊕	16 (6)	10 to 25 (8 to 3)	10 (8)	10 to 25 (8 to 3)	M8	8.8 to 10.8 (78.1 to 95.5)
	p1, n1	2.5 (14)	2.5 to 4 (14 to 12)	2.5 (14)	2.5 to 4 (14 to 12)	M4	1 to 1.4 (8.9 to 12.4)
4□0065	R/L1, S/L2, T/L3	25 (4)	16 to 25 (6 to 3)	16 (5)	10 to 25 (8 to 3)	M6	4 to 6 (35.4 to 53.1)
	U/T1, V/T2, W/T3	25 (4)	16 to 25 (6 to 3)	16 (5)	10 to 25 (8 to 3)	M6	
	⊕	16 (6)	16 to 25 (6 to 3)	16 (5)	16 to 25 (5 to 3)	M8	8.8 to 10.8 (78.1 to 95.5)
	p1, n1	2.5 (14)	2.5 to 4 (14 to 12)	2.5 (14)	2.5 to 4 (14 to 12)	M4	1 to 1.4 (8.9 to 12.4)
4□0077	R/L1, S/L2, T/L3	25 (3)	25 (4 to 3)	25 (3)	16 to 25 (5 to 3)	M6	4 to 6 (35.4 to 53.1)
	U/T1, V/T2, W/T3	25 (3)	25 (4 to 3)	25 (3)	16 to 25 (5 to 3)	M6	
	⊕	16 (6)	16 to 25 (6 to 3)	16 (5)	16 to 25 (5 to 3)	M8	8.8 to 10.8 (78.1 to 95.5)
	p1, n1	2.5 (14)	2.5 to 4 (14 to 12)	2.5 (14)	2.5 to 4 (14 to 12)	M4	1 to 1.4 (8.9 to 12.4)

Drive Model	Terminal	For USA and Canada		For South America		Screw Size	Tightening Torque N·m (lb.in.)
		Recomm. Gauge mm ² (AWG, kcmil)	Wire Range mm ² (AWG, kcmil)	Recomm. Gauge mm ² (AWG, kcmil)	Wire Range mm ² (AWG, kcmil)		
4□0096	R/L1, S/L2, T/L3	35 (1)	10 to 50 (8 to 1/0 × 2P)	35 (1)	10 to 50 × 2P (8 to 1/0 × 2P)	M8	8 to 10 (70.8 to 88.5)
	U/T1, V/T2, W/T3	35 (1)	10 to 50 (8 to 1/0 × 2P)	35 (1)	10 to 50 × 2P (8 to 1/0 × 2P)	M8	
	⊕	25 (4)	25 to 35 (4 to 1)	25 (3)	10 to 35 (8 to 1)	M8	8.8 to 10.8 (78.1 to 95.5)
	p1, n1	2.5 (14)	2.5 to 4 (14 to 12)	2.5 (14)	2.5 to 4 (14 to 12)	M4	1.2 to 2.0 (10.4 to 17.4)
4□0124	R/L1, S/L2, T/L3	25 × 2 (4 × 2P)	16 to 50 × 2 (6 to 1/0 × 2P)	16 × 2P (5 × 2P)	10 to 50 × 2P (8 to 1/0 × 2P)	M8	8 to 10 (70.8 to 88.5)
	U/T1, V/T2, W/T3	25 × 2 (4 × 2P)	16 to 50 × 2 (6 to 1/0 × 2P)	16 × 2P (5 × 2P)	10 to 50 × 2P (8 to 1/0 × 2P)	M8	
	⊕	25 (4)	25 to 35 (4 to 1)	16 (5)	16 to 35 (5 to 1)	M8	8.8 to 10.8 (78.1 to 95.5)
	p1, n1	2.5 (14)	2.5 to 4 (14 to 12)	2.5 (14)	2.5 to 4 (14 to 12)	M4	1.2 to 2.0 (10.4 to 17.4)
4□0156	R/L1, S/L2, T/L3	25 × 2 (3 × 2P)	25 to 95 × 2 (4 to 4/0 × 2P)	25 × 2P (3 × 2P)	16 to 95 × 2P (5 to 4/0 × 2P)	M10	15 to 20 (130 to 173)
	U/T1, V/T2, W/T3	25 × 2 (3 × 2P)	25 to 95 × 2 (4 to 4/0 × 2P)	25 × 2P (3 × 2P)	16 to 95 × 2P (5 to 4/0 × 2P)	M10	
	⊕	25 (4)	25 to 70 (4 to 2/0)	25 (3)	25 to 70 (3 to 2/0)	M10	17.7 to 22.6 (156 to 200)
	p1, n1	2.5 (14)	2.5 to 4 (14 to 12)	2.5 (14)	2.5 to 4 (14 to 12)	M4	1.2 to 2.0 (10.4 to 17.4)
4□0180	R/L1, S/L2, T/L3	35 × 2 (2 × 2P)	25 to 95 × 2 (3 to 4/0 × 2P)	25 × 2P (3 × 2P)	25 to 95 × 2P (3 to 4/0 × 2P)	M10	15 to 20 (130 to 173)
	U/T1, V/T2, W/T3	35 × 2 (2 × 2P)	25 to 95 × 2 (3 to 4/0 × 2P)	25 × 2P (3 × 2P)	25 to 95 × 2P (3 to 4/0 × 2P)	M10	
	⊕	25 (3)	25 to 70 (4 to 2/0)	25 (3)	25 to 70 (3 to 2/0)	M10	17.7 to 22.6 (156 to 200)
	p1, n1	2.5 (14)	2.5 to 4 (14 to 12)	2.5 (14)	2.5 to 4 (14 to 12)	M4	1.2 to 2.0 (10.4 to 17.4)
4□0216	R/L1, S/L2, T/L3	50 × 2 (1/0 × 2P)	35 to 95 × 2 (2 to 4/0 × 2P)	35 × 2P (1 × 2P)	25 to 95 × 2P (3 to 4/0 × 2P)	M10	15 to 20 (130 to 173)
	U/T1, V/T2, W/T3	50 × 2 (1/0 × 2P)	35 to 95 × 2 (2 to 4/0 × 2P)	35 × 2P (1 × 2P)	25 to 95 × 2P (3 to 4/0 × 2P)	M10	
	⊕	25 (3)	25 to 95 (4 to 4/0)	35 (1)	25 to 95 (3 to 4/0)	M12	31.4 to 39.2 (278 to 347)
	p1, n1	2.5 (14)	2.5 to 4 (14 to 12)	2.5 (14)	2.5 to 4 (14 to 12)	M4	1.2 to 2.0 (10.4 to 17.4)
4□0240	R/L1, S/L2, T/L3	50 × 2 (1/0 × 2P)	50 to 95 × 2 (1/0 to 4/0 × 2P)	50 × 2P (1/0 × 2P)	35 to 95 × 2P (1 to 4/0 × 2P)	M10	15 to 20 (130 to 173)
	U/T1, V/T2, W/T3	50 × 2 (1/0 × 2P)	50 to 95 × 2 (1/0 to 4/0 × 2P)	50 × 2P (1/0 × 2P)	35 to 95 × 2P (1 to 4/0 × 2P)	M10	
	⊕	35 (2)	35 to 95 (2 to 4/0)	50 (1/0)	35 to 95 (1 to 4/0)	M12	31.4 to 39.2 (278 to 347)
	p1, n1	2.5 (14)	2.5 to 4 (14 to 12)	2.5 (14)	2.5 to 4 (14 to 12)	M4	1.2 to 2.0 (10.4 to 17.4)
4□0302 </>	R/L1, S/L2, T/L3	70 × 2 (3/0 × 2P)	50 to 95 × 2 (1/0 to 4/0 × 2P)	70 × 2P (3/0 × 2P)	50 to 95 × 2P (1/0 to 4/0 × 2P)	M10	15 to 20 (130 to 173)
	U/T1, V/T2, W/T3	70 × 2 (3/0 × 2P)	50 to 95 × 2 (1/0 to 4/0 × 2P)	70 × 2P (3/0 × 2P)	50 to 95 × 2P (1/0 to 4/0 × 2P)	M10	
	⊕	35 (1)	35 to 150 (1 to 300)	70 (3/0)	35 to 150 (1 to 300)	M12	31.4 to 39.2 (278 to 347)
	p1, n1	2.5 (14)	2.5 to 4 (14 to 12)	2.5 (14)	2.5 to 4 (14 to 12)	M4	1.2 to 2.0 (10.4 to 17.4)

i.4 Electrical Installation

Drive Model	Terminal	For USA and Canada		For South America		Screw Size	Tightening Torque N·m (lb.in.)
		Recomm. Gauge mm ² (AWG, kcmil)	Wire Range mm ² (AWG, kcmil)	Recomm. Gauge mm ² (AWG, kcmil)	Wire Range mm ² (AWG, kcmil)		
4□0361 </>	R/L1, S/L2, T/L3	95 × 2 (4/0 × 2P)	70 to 95 × 2 (3/0 to 4/0 × 2P)	95 × 2P (4/0 × 2P)	70 to 95 × 2P (3/0 to 4/0 × 2P)	M10	15 to 20 (130 to 173)
	U/T1, V/T2, W/T3	95 × 2 (4/0 × 2P)	70 to 95 × 2 (3/0 to 4/0 × 2P)	95 × 2P (4/0 × 2P)	70 to 95 × 2P (3/0 to 4/0 × 2P)	M10	
	⊕	50 (1/0)	50 to 150 (1/0 to 300)	95 (4/0)	70 to 150 (3/0 to 300)	M12	31.4 to 39.2 (278 to 347)
	p1, n1	2.5 (14)	2.5 to 4 (14 to 12)	2.5 (14)	2.5 to 4 (14 to 12)	M4	1.2 to 2.0 (10.4 to 17.4)
4□0414 </>	R/L1, S/L2, T/L3	150 × 2 (300 × 2P)	95 to 150 × 2 (4/0 to 300 × 2P)	95 × 2P (4/0 × 2P)	95 to 150 × 2P (4/0 to 300 × 2P)	M12	25 to 35 (217 to 304)
	U/T1, V/T2, W/T3	150 × 2 (300 × 2P)	95 to 150 × 2 (4/0 to 300 × 2P)	95 × 2P (4/0 × 2P)	95 to 150 × 2P (4/0 to 300 × 2P)	M12	
	⊕	50 (1/0)	50 to 240 (1/0 to 400)	95 (4/0)	70 to 240 (3/0 to 400)	M12	31.4 to 39.2 (278 to 347)
	p1, n1	2.5 (14)	2.5 to 4 (14 to 12)	2.5 (14)	2.5 to 4 (14 to 12)	M4	1.2 to 2.0 (10.4 to 17.4)

<1> Take additional measures in accordance with IEC/EN 61800-5-1:2007 when wiring an EMC filter is installed. [Refer to Internal EMC Filter Installation on page 80](#) for details.

◆ Main Circuit Terminal and Motor Wiring

This section outlines the various steps, precautions, and checkpoints for wiring the main circuit terminals and motor terminals.

NOTICE: When connecting the motor to the drive output terminals U/T1, V/T2, and W/T3, the phase order for the drive and motor should match. Failure to comply with proper wiring practices may cause the motor to run in reverse if the phase order is backward.

NOTICE: Do not connect phase-advancing capacitors or LC/RC noise filters to the output circuits. Failure to comply could result in damage to the drive, phase-advancing capacitors, LC/RC noise filters, or ground fault circuit interrupters.

■ Ground Wiring

Follow the precautions below when wiring the ground for one drive or a series of drives.

WARNING! Electrical Shock Hazard. Always use a ground wire that complies with technical standards on electrical equipment and minimize the length of the ground wire. Improper equipment grounding may cause dangerous electrical potentials on equipment chassis, which could result in death or serious injury.

WARNING! Electrical Shock Hazard. Be sure to ground the drive ground terminal (200 V class: ground to 100 Ω or less; 400 V class: ground to 10 Ω or less). Improper equipment grounding could result in death or serious injury by contacting ungrounded electrical equipment.

NOTICE: Do not share the ground wire with other devices such as welding machines or large-current electrical equipment. Improper equipment grounding could result in drive or equipment malfunction due to electrical interference.

NOTICE: When using more than one drive, ground multiple drives according to instructions. Improper equipment grounding could result in abnormal operation of drive or equipment.

Refer to [Figure i.16](#) when using multiple drives. Do not loop the ground wire.

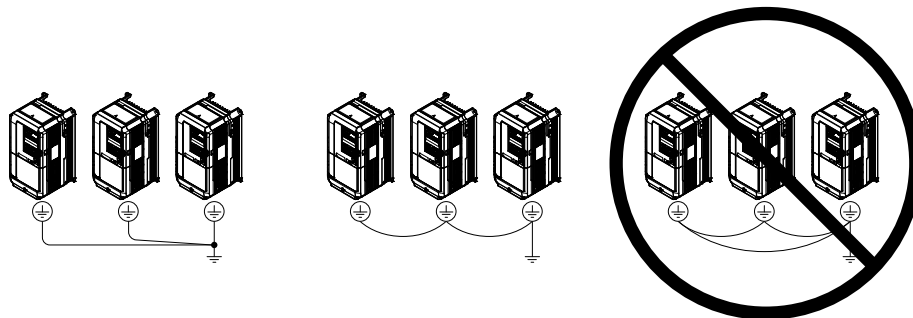


Figure i.16 Multiple Drive Wiring

◆ Control Circuit Terminal Block Functions

Drive parameters determine which functions apply to the multi-function digital inputs (S1 to S8), multi-function digital outputs (M1 to M4, MD to MF), multi-function analog inputs (A1 to A3), and multi-function analog monitor outputs (FM, AM). The default setting is listed next to each terminal in [Figure i.12](#) on page 20.

WARNING! Sudden Movement Hazard. Always check the operation and wiring of control circuits after being wired. Operating a drive with untested control circuits could result in death or serious injury.

WARNING! Sudden Movement Hazard. Confirm the drive I/O signals and external sequence before starting test run. Setting parameter A1-03 may change the I/O terminal function automatically from the factory setting. Failure to comply may result in death or serious injury.

■ Input Terminals

[Table i.7](#) lists the input terminals on the drive. Text in parenthesis indicates the default setting for each multi-function input.

Table i.7 Control Circuit Input Terminals

Type	No.	Terminal Name (Function)	Function (Signal Level) Default Setting
Multi-Function Digital Inputs	S1	Multi-function input 1 (Closed: Forward run, Open: Stop)	<ul style="list-style-type: none"> • Photocoupler • 24 Vdc, 8 mA • Refer to Sinking/Sourcing Mode for Digital Inputs on page 33.
	S2	Multi-function input 2 (Closed: Reverse run, Open: Stop)	
	S3	Multi-function input 3 (External fault, N.O.)	
	S4	Multi-function input 4 (Fault reset)	
	S5	Multi-function input 5 (Multi-step speed reference 1)	
	S6	Multi-function input 6 (Multi-step speed reference 2)	
	S7	Multi-function input 7 (Jog reference)	
	S8	Multi-function input 8 (Baseblock command (N.O.))	
	SC	Multi-function input common	Multi-function input common
	SP	Digital input power supply +24 Vdc	24 Vdc power supply for digital inputs, 150 mA max
	SN	Digital input power supply 0 V 24 V transducer power supply 0 V	NOTICE: Do not jumper or short terminals SP and SN. Failure to comply will damage the drive.
Analog Inputs / Pulse Train Input	RP	Multi-function pulse train input (Frequency reference)	<ul style="list-style-type: none"> • Input frequency range: 0 to 32 kHz • Signal Duty Cycle: 30 to 70% • High level: 3.5 to 13.2 Vdc, low level: 0.0 to 0.8 Vdc • Input impedance: 3 kΩ
	+V	Power supply for analog inputs	10.5 Vdc (max allowable current 20 mA)
	24 V	+24 Vdc transducer power supply for customer use	150 mA maximum capacity
	A1	Multi-function analog input 1 (Frequency reference bias)	<ul style="list-style-type: none"> • -10 to 10 Vdc, 0 to 10 Vdc (input impedance: 20 kΩ) • 4 to 20 mA, 0 to 20 mA (input impedance: 250 Ω) • Voltage or current input must be selected by jumper S1 and H3-01.
	A2	Multi-function analog input 2 (Frequency reference bias)	<ul style="list-style-type: none"> • -10 to 10 Vdc, 0 to 10 Vdc (input impedance: 20 kΩ) • 4 to 20 mA, 0 to 20 mA (input impedance: 250 Ω) • Voltage or current input must be selected by jumper S1 and H3-09.
	A3	Multi-function analog input 3 (Frequency reference bias)	<ul style="list-style-type: none"> • -10 to 10 Vdc, 0 to 10 Vdc (input impedance: 20 kΩ) • 4 to 20 mA, 0 to 20 mA (input impedance: 250 Ω) • Voltage or current input must be selected by jumper S1 and H3-05.
	AC	Frequency reference common	0 V
E (G)	Ground for shielded lines and option cards	—	

i.4 Electrical Installation

Output Terminals

Table i.8 lists the output terminals on the drive. Text in parenthesis indicates the default setting for each multi-function output.

Table i.8 Control Circuit Output Terminals

Type	No.	Terminal Name (Function)	Function (Signal Level) Default Setting
Fault Relay Output	MA	N.O.	30 Vdc, 10 mA to 1 A; 250 Vac, 10 mA to 1 A Minimum load: 5 Vdc, 10 mA
	MB	N.C. output	
	MC	Fault output common	
Multi-Function Digital Output <1>	MD	N.O.	30 Vdc, 10 mA to 1 A; 250 Vac, 10 mA to 1 A Minimum load: 5 Vdc, 10 mA
	ME	N.C. Output	
	MF	Common (Speed agree)	
	M1	Multi-function digital output (During run)	30 Vdc, 10 mA to 1 A; 250 Vac, 10 mA to 1 A Minimum load: 5 Vdc, 10 mA
	M2		
	M3	Multi-function digital output (Zero speed)	
	M4		
Monitor Output	FM	Analog monitor output 1 (Output frequency)	-10 to +10 Vdc, or 0 to +10 Vdc
	AM	Analog monitor output 2 (Output current)	
	AC	Monitor common	0 V
External Power Supply	24V	External Power Supply	24 V (Max. 150 mA)

<1> Refrain from assigning functions to digital relay outputs that involve frequent switching, as doing so may shorten relay performance life. Switching life is estimated at 200,000 times (assumes 1 A, resistive load).

Serial Communication Terminals

Table i.9 Control Circuit Terminals: Serial Communications

Type	No.	Signal Name	Function (Signal Level)
Serial Communication (APOGEE FLN, BACnet, MEMOBUS/Modbus, or Metasys N2) <1>	R+	Communications input (+)	APOGEE FLN, BACnet, MEMOBUS/Modbus, or Metasys N2 communication: Use an RS-422 or RS-485 cable to connect the drive. <ul style="list-style-type: none"> • APOGEE FLN Comm. RS-422/RS-485, 4.8 kbps • BACnet Comm. RS-485, max. 76.8 kbps • MEMOBUS/Modbus Comm. RS-422/RS-485, max. 115.2 kbps • Metasys N2 Comm. RS-422/RS-485, 9.6 kbps
	R-	Communications input (-)	
	S+	Communications output (+)	
	S-	Communications output (-)	
	IG	Communications ground	0 V
	FE	Option card ground	—

<1> Enable the termination resistor in the last drive in an APOGEE FLN, BACnet, MEMOBUS/Modbus, or Metasys N2 network by setting DIP switch S2 to the ON position. Refer to TOEPC71063610 Z1000U User Manual section on **Control I/O Connections** for more information.

◆ Terminal Configuration

The control circuit terminals should be arranged as shown in [Figure i.17](#).

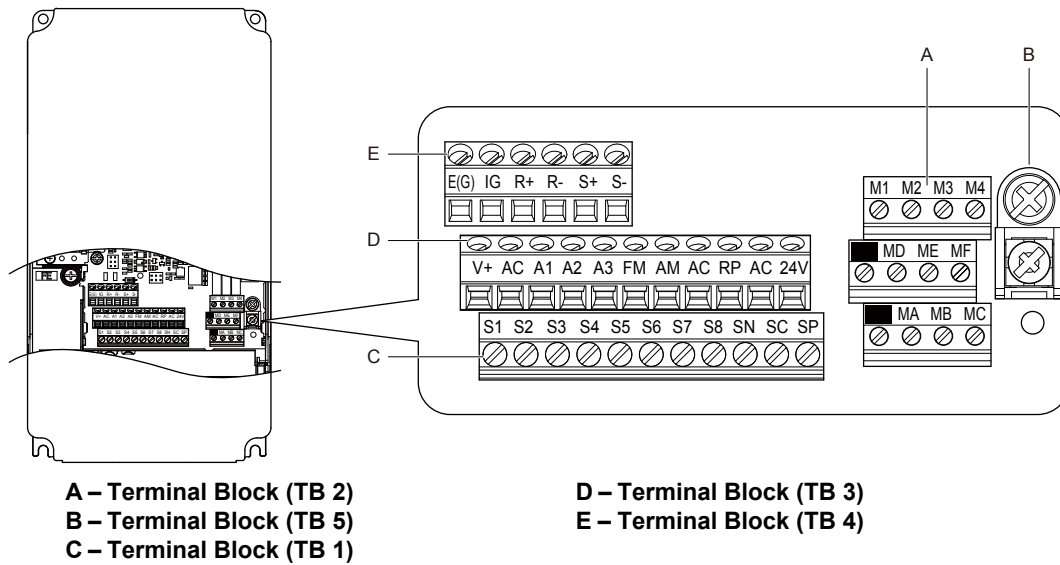


Figure i.17 Control Circuit Terminal Arrangement

■ Wire Size and Torque Specifications

Select appropriate wire type and gauges from [Table i.10](#). For simpler and more reliable wiring, use crimp ferrules on the wire ends.

Table i.10 Wire Gauges

Terminal Block	Terminal	Screw Size	Tightening Torque N•m (lb. in)	Bare Wire Terminal		Ferrule-Type Terminal		Wire Type
				Recomm. wire size mm ² (AWG)	Applicable wire size mm ² (AWG)	Recomm. wire size mm ² (AWG)	Applicable wire size mm ² (AWG)	
TB1, TB2, TB3, TB4	IG, R+, R-, S+, S-, V+, AC, A1, A2, A3, FM, AM, AC, RP, AC, 24V, S1-S8, SN, SC, SP, M1, M2, M3, M4, MD, ME, MF, MA, MB, MC	M3	0.5 to 0.6 (4.4 to 5.3)	0.75 (18)	Stranded wire: 0.2 to 1.0 (24 to 17) Solid wire: 0.2 to 1.5 (24 to 16)	0.5 (20)	0.25 to 0.5 (24 to 20)	Shielded wire, etc.
	E(G)			1.0 (16)				
TB5	E(G)	M3.5	0.5 to 1.0 (4.4 to 8.9)	1.25 (12)	0.5 to 2 (20 to 14)	–	–	

■ Ferrule-Type Wire Terminals

Yaskawa recommends using CRIMPFOX 6, a crimping tool manufactured by PHOENIX CONTACT, to prepare wire ends with insulated sleeves. See [Table i.11](#) for dimensions.

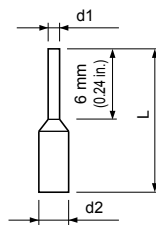


Figure i.18 Ferrule Dimensions

i.4 Electrical Installation

Table i.11 Ferrule Terminal Types and Sizes

Size mm ² (AWG)	Type	L mm (in)	d1 mm (in)	d2 mm (in)	Manufacturer
0.25 (24)	AI 0.25-8YE	12.5 (0.49)	0.8 (0.03)	2.0 (0.08)	PHOENIX CONTACT
0.34 (22)	AI 0.34-8TQ	12.5 (0.49)	0.8 (0.03)	2.0 (0.08)	
0.5 (20)	AI 0.5-8WH AI 0.5-8OG	14.0 (0.55)	1.1 (0.04)	2.5 (0.10)	

◆ Wiring the Control Circuit Terminal

This section describes the proper procedures and preparations for wiring the control terminals.

WARNING! *Electrical Shock Hazard. Do not remove covers or touch the circuit boards while the power is on. Failure to comply could result in death or serious injury.*

NOTICE: *Separate control circuit wiring from main circuit wiring and other high-power lines. Improper wiring practices could result in drive malfunction due to electrical interference. Main circuit terminals vary by drive model. Refer to Main Circuit Terminal Functions on page 22 for details.*

NOTICE: *Separate wiring for digital output terminals MA, MB, MC, MD, ME, MF, and M1 to M4 from wiring to other control circuit lines. Improper wiring practices could result in drive or equipment malfunction or nuisance trips.*

NOTICE: *Use a class 2 power supply when connecting to the control terminals. Improper application of peripheral devices could result in drive performance degradation due to improper power supply. Refer to NEC Article 725 Class 1, Class 2, and Class 3 Remote-Control, Signaling, and Power Limited Circuits for requirements concerning class 2 power supplies.*

NOTICE: *Insulate shields with tape or shrink tubing to prevent contact with other signal lines and equipment. Improper wiring practices could result in drive or equipment malfunction due to short circuit.*

NOTICE: *Connect the shield of shielded cable to the appropriate ground terminal. Improper equipment grounding could result in drive or equipment malfunction or nuisance trips.*

Wire the control circuit only after terminals have been properly grounded and main circuit wiring is complete. Refer to Terminal Board Wiring Guide on page 32 for details. Prepare the ends of the control circuit wiring as shown in Figure i.21. Refer to Wire Gauges on page 31.

NOTICE: *Do not tighten screws beyond the specified tightening torque. Failure to comply may result in erroneous operation, damage to the terminal block, or cause a fire.*

NOTICE: *Use shielded twisted-pair cables as indicated to prevent operating faults. Improper wiring practices could result in drive or equipment malfunction due to electrical interference.*

Wire the control circuit only after terminals have been properly grounded and main circuit wiring is complete. Refer to Terminal Board Wiring Guide on page 32 for details. Prepare the ends of the control circuit wiring as shown in Figure i.21. Refer to Wire Gauges on page 31.

Connect control wires as shown in Figure i.19 and Figure i.20.

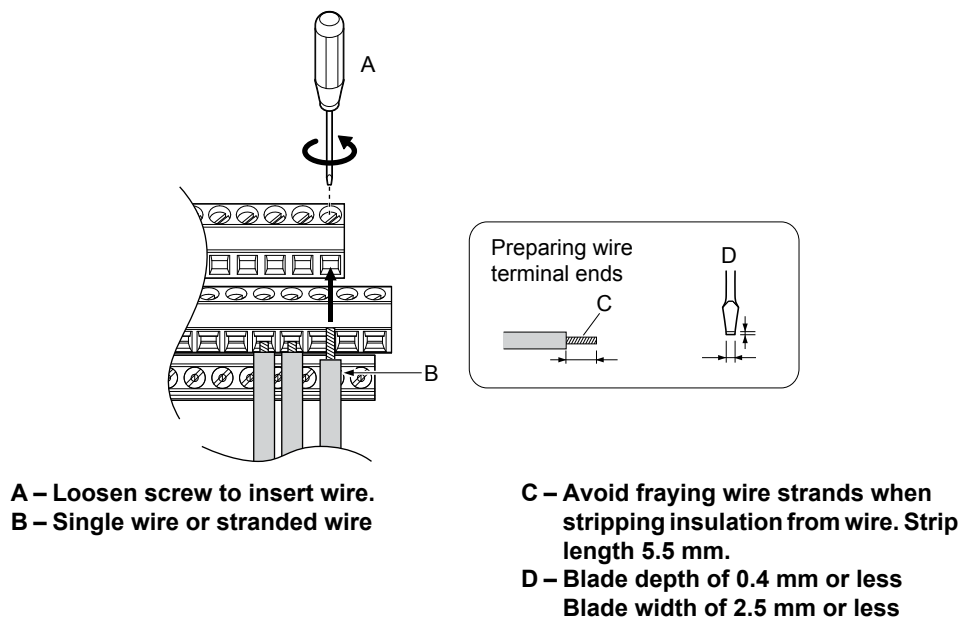


Figure i.19 Terminal Board Wiring Guide

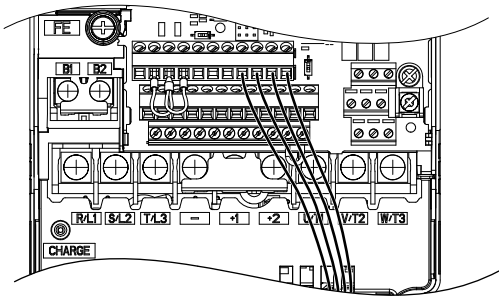
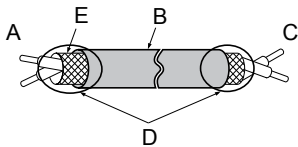


Figure i.20 Terminal Board Location Inside the Drive



- A – Drive side
- B – Insulation
- C – Control device side
- D – Shield sheath (insulate with tape)
- E – Shield

Figure i.21 Preparing the Ends of Shielded Cables

NOTICE: The analog signal wiring between the drive and the operator station or peripheral equipment should not exceed 50 meters when using an analog signal from a remote source to supply the frequency reference. Failure to comply could result in poor system performance.

◆ Sinking/Sourcing Mode for Digital Inputs

Use the wire jumper between terminals SC and SP or SC and SN to select between Sink mode, Source mode or external power supply for the digital inputs S1 to S8 as shown in [Table i.12](#) (Default: Sink mode, internal power supply).

NOTICE: Do not short terminals SP and SN. Failure to comply will damage the drive.

Table i.12 Digital Input Sink/Source/External Power Supply Selection

Mode	Drive Internal Power Supply (Terminals SN and SP)	External 24 Vdc Power Supply
Sinking Mode (NPN)		
Sourcing Mode (PNP)		

◆ Terminals A1, A2, and A3 Input Signal Selection

Terminals A1, A2, and A3 can be used to input either a voltage or a current signal. Select the signal type using jumper S1 as explained in [Table i.13](#). Set parameters H3-01, H3-05, and H3-09 accordingly as shown in [Table i.14](#).

Note: If terminals A1 and A2 are both set for frequency bias (H3-02 = 0 and H3-10 = 0), both input values will be combined to create the frequency reference.

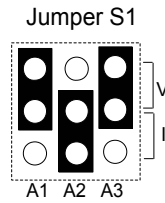


Figure i.22 Terminal A2 Set to Current Input; A1 and A3 Set to Voltage Input

Table i.13 Jumper S1 Settings

Setting	Description
V (top position)	Voltage input (-10 to +10 V or 0 to 10 V)
I (bottom position)	Current input (4 to 20 mA or 0 to 20 mA)

Table i.14 Voltage/Current Selection Parameter Details

No.	Parameter Name	Description	Setting Range	Default Setting
H3-01	Terminal A1 signal level selection	Selects the signal level for terminal A1. 0: 0 to 10 Vdc 1: 0 to 10 Vdc Bipolar 2: 4 to 20 mA 3: 0 to 20 mA	0 to 3	0
H3-05	Terminal A3 signal level selection	Selects the signal level for terminal A3. 0: 0 to 10 Vdc 1: 0 to 10 Vdc Bipolar 2: 4 to 20 mA 3: 0 to 20 mA	0 to 3	0
H3-09	Terminal A2 signal level selection	Selects the signal level for terminal A2. 0: 0 to 10 Vdc 1: 0 to 10 Vdc Bipolar 2: 4 to 20 mA 3: 0 to 20 mA	0 to 3	2

◆ Terminal AM/FM Signal Selection

The signal type for terminals AM and FM can be set to either voltage or current output using jumper S5 on the terminal board as explained in [Table i.15](#). When changing the setting of jumper S5, parameters H4-07 and H4-08 must be set accordingly. The default selection is voltage output for both terminals.

Table i.15 Jumper S5 Settings

Terminal	Voltage Output	Current Output
Terminal AM		
Terminal FM		

Table i.16 Parameter H4-07 and H4-08 Details

No.	Parameter Name	Description	Setting Range	Default Setting
H4-07	Terminal FM signal level selection	0: 0 to 10 Vdc 1: -10 to 10 Vdc	0 to 2	0
H4-08	Terminal AM signal level selection	2: 4 to 20 mA		

◆ MEMOBUS/Modbus Termination

This drive is equipped with a built-in termination resistor for the RS-422/RS-485 communication port. DIP switch S2 enables or disabled the termination resistor as shown in [Table i.17](#). The OFF position is the default. The termination resistor should be placed to the ON position when the drive is the last in a series of slave drives.

Table i.17 MEMOBUS/Modbus Switch Settings

S2 Position	Description
ON	Internal termination resistor ON
OFF	Internal termination resistor OFF (default setting)

◆ Enable the Internal EMC Filter

Drive models Z□□E□□□□/Z□□W□□□□ have a built-in EMC filter. Move the EMC filter screw to enable (ON) and disable (OFF) the EMC filter.

DANGER! *Electrical Shock Hazard. Do not touch SW screw while power is applied to the drive. Failure to comply will result in death or serious injury.*

WARNING! *Electrical Shock Hazard. Connect the ground cable correctly. Failure to comply may result in death or serious injury.*

NOTICE: *When disabling the internal EMC filter, move the screws from ON to OFF and then tighten to the specified torque. Completely removing the screws or tightening the screws to an incorrect torque may cause drive failure.*

NOTICE: *Prevent Drive Damage: Install the two EMC filter screws in the same position (ON and ONE, or OFF and OFF). Failure to comply may result in serious damage to the drive.*

NOTICE: *Prevent Drive Damage: Install the EMC filter screw in the OFF position. Installing the EMC filter screw disables the internal EMC filter in the network is grounded as follows. Failure to comply may result in serious damage to the drive.*

- Floating network
- High impedance grounded network
- Asymmetrically grounded network

Use size M4 internal EMC filter screws with 1.0 to 1.3 N·m tightening torque.

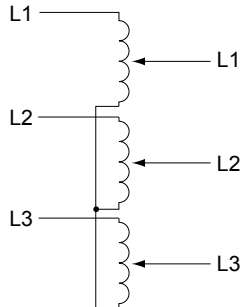
■ Asymmetrical Grounded Network

[Table i.18](#) shows asymmetrical grounded networks. Asymmetrical networks require first moving the SW screw to disconnect the internal ground connection. (Drives are shipped with the SW screw installed at the OFF position.)

Table i.18 Asymmetrical Grounded Network

Characteristics	Diagram
Grounded at the corner of the delta	
Grounded at the middle of the side	
Single-phase, grounded at the end point	

i.4 Electrical Installation

Characteristics	Diagram
<p>Three-phase variable transformer without solidly grounded neutral</p>	

■ Symmetrical Grounded Network

When EMC is a concern for drives with internal EMC filters and the network is grounded symmetrically, install the EMC filter screw to the ON position and enable the internal EMC filter.

Drives ship from the factory with EMC filter screws installed in the OFF position.

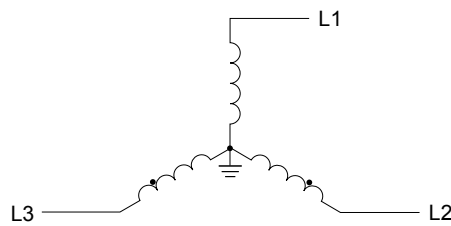
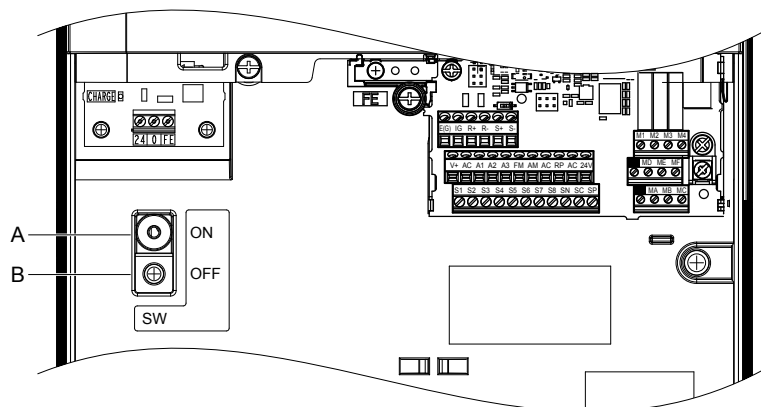


Figure i.23 Symmetrical Grounded Network

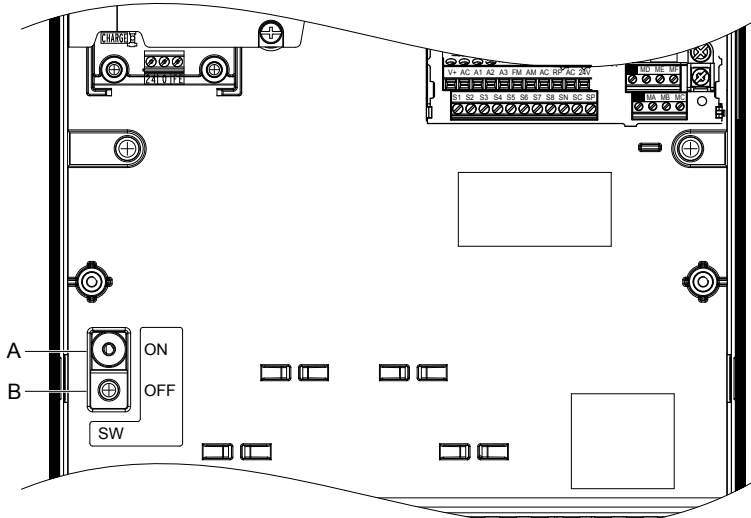
■ EMC Filter Switch Location



A – SW (ON)

B – Screw (OFF)

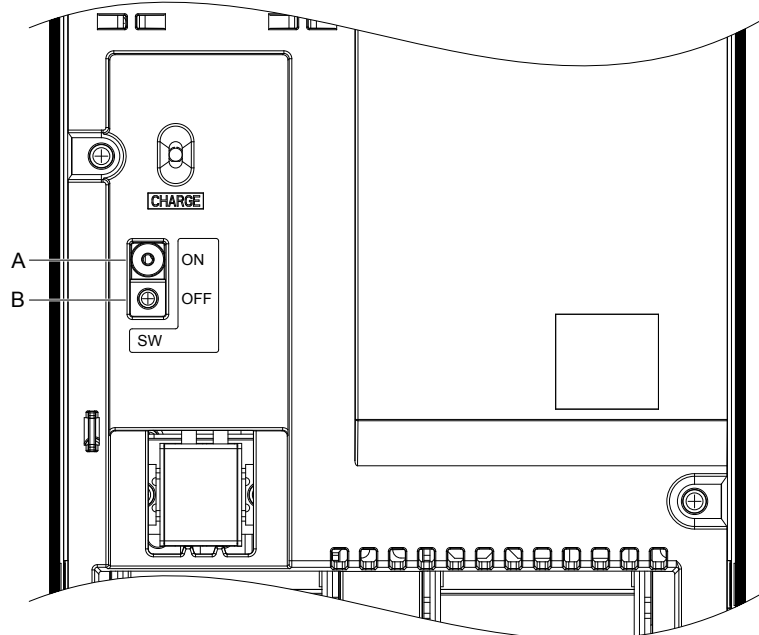
Figure i.24 EMC Filter Switch Location
(Drive Models 2E0028, 2W0028, 4E0011 to 4E0034, and 4W0011 to 4W0034)



A – SW (ON)

B – Screw (OFF)

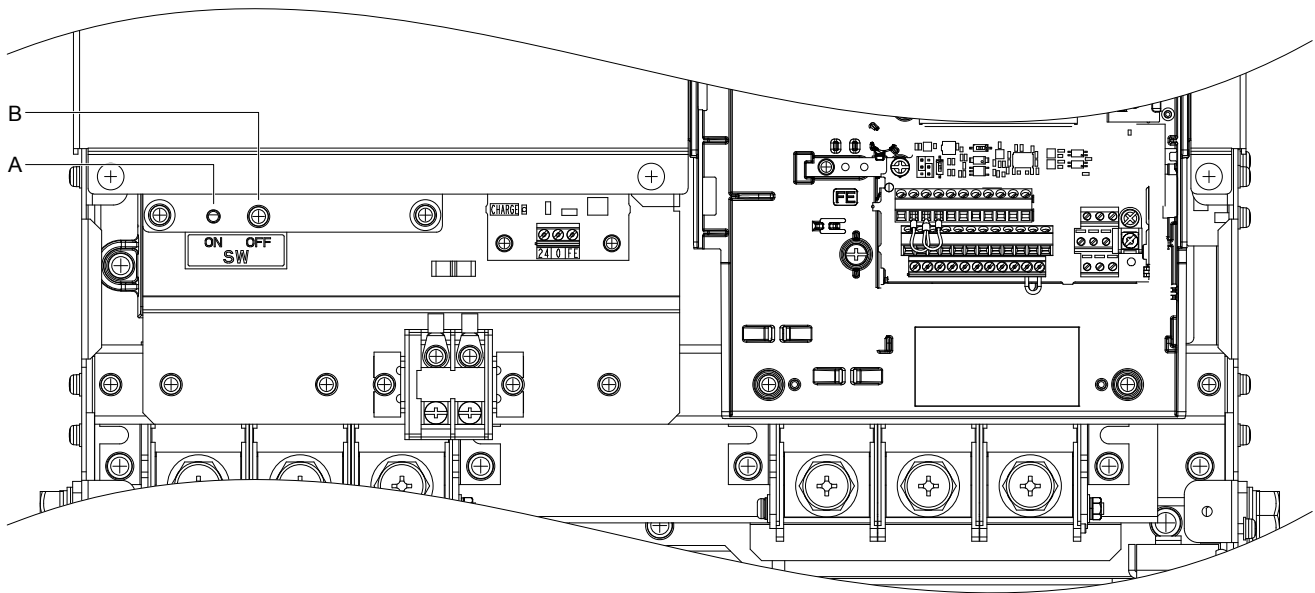
Figure i.25 EMC Filter Switch Location
(Drive Models 2E0042, 2W0042, 2E0054, 2W0054, 4E0040 to 4E0077, and 4W0040 to 4W0077)



A – SW (ON)

B – Screw (OFF)

Figure i.26 EMC Filter Switch Location
(Drive Models 2E0104, 2W0104, 2E0130, 2W0130, 4E0096, 4W0096, 4E0124, and 4W0124)

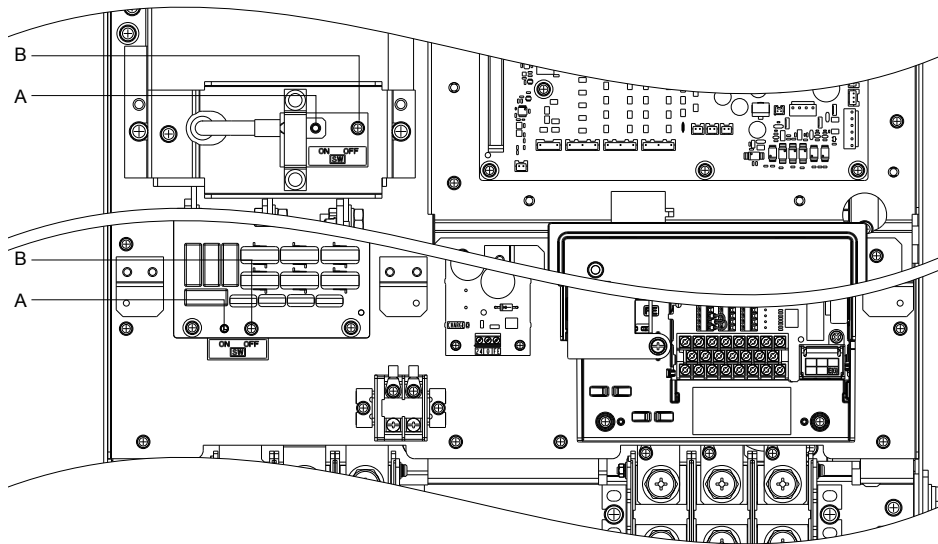


A – SW (ON)

B – Screw (OFF)

Figure i.27 EMC Filter Switch Location

(Drive Models 2E0154, 2W0154, 2E0192, 2W0192, 4E0156, 4W0156, 4E0180, and 4W0180)

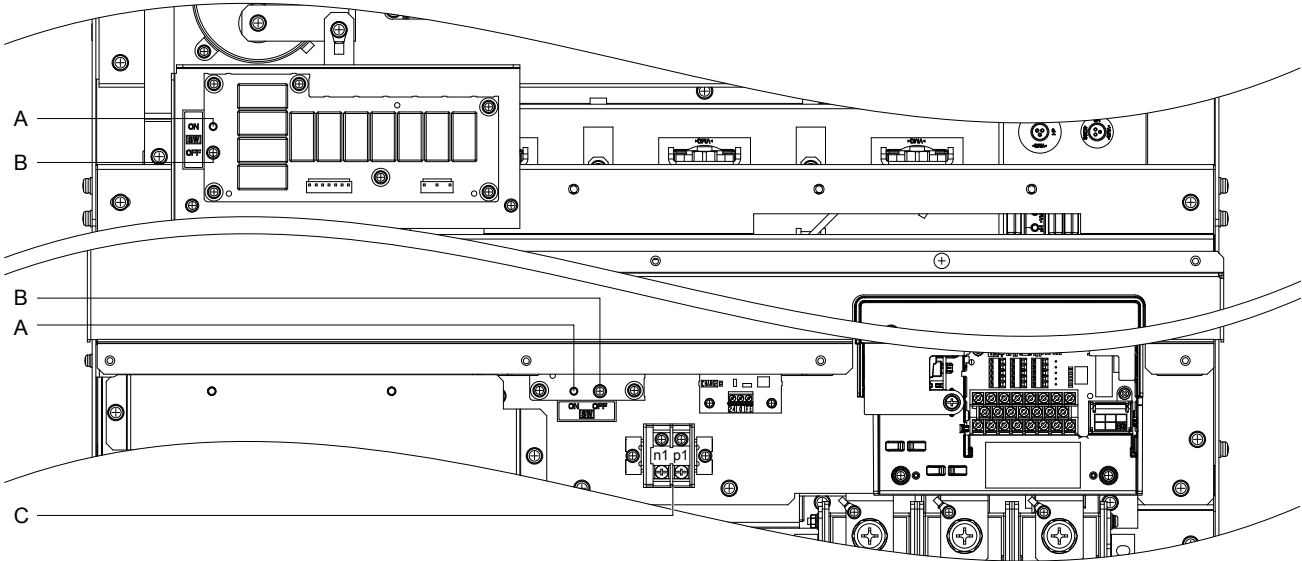


A – SW (ON)

B – Screw (OFF)

Figure i.28 EMC Filter Switch Location

(Drive Models 2E0248, 2W0248, 4EU0216, 4W0216, 4E0240, and 4W0240)



A – SW (ON)
 B – Screw (OFF)

C – Terminals p1 and n1

Figure i.29 EMC Filter Switch Location
 (Drive Models 4E0302 to 4E0414 and 4W0302 to 4W0414)

◆ 24 V Control Power Supply Unit Wiring

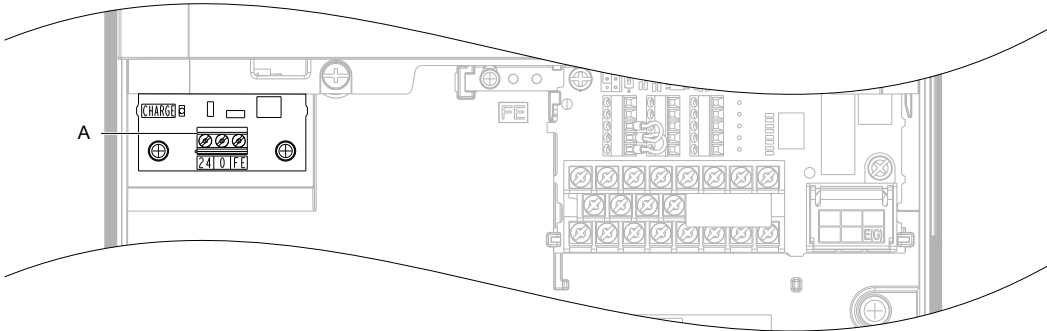
■ 24 V Control Power Supply Unit

The 24 V Control Power Supply Unit maintains drive control circuit power in the event of a main power outage. As long as the control circuit has power, network communications and I/O data remain operational. The unit provides external power to the control circuit only, and does not provide power to the main circuit of the drive.

It is possible to read fault and parameter data in the drive via the operator or network communications when the drive switches to the 24 V Control Power Supply Unit as a back-up power supply.

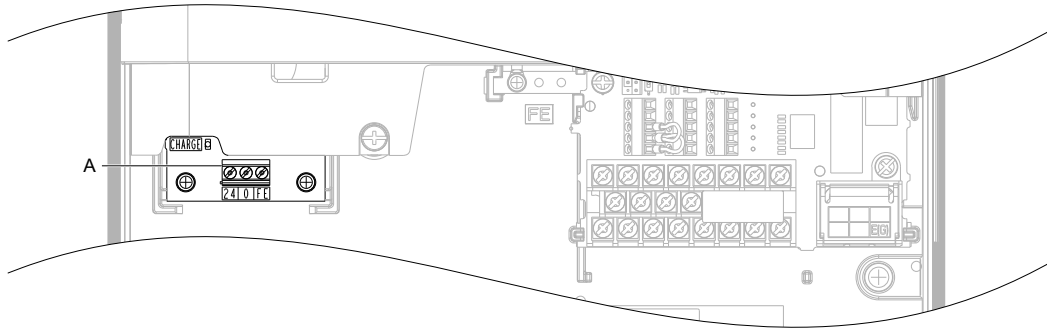
Note: Parameter settings cannot be changed without drive main circuit power regardless of whether the control circuit has enough power to operate.

■ 24 V Control Power Supply Unit Location



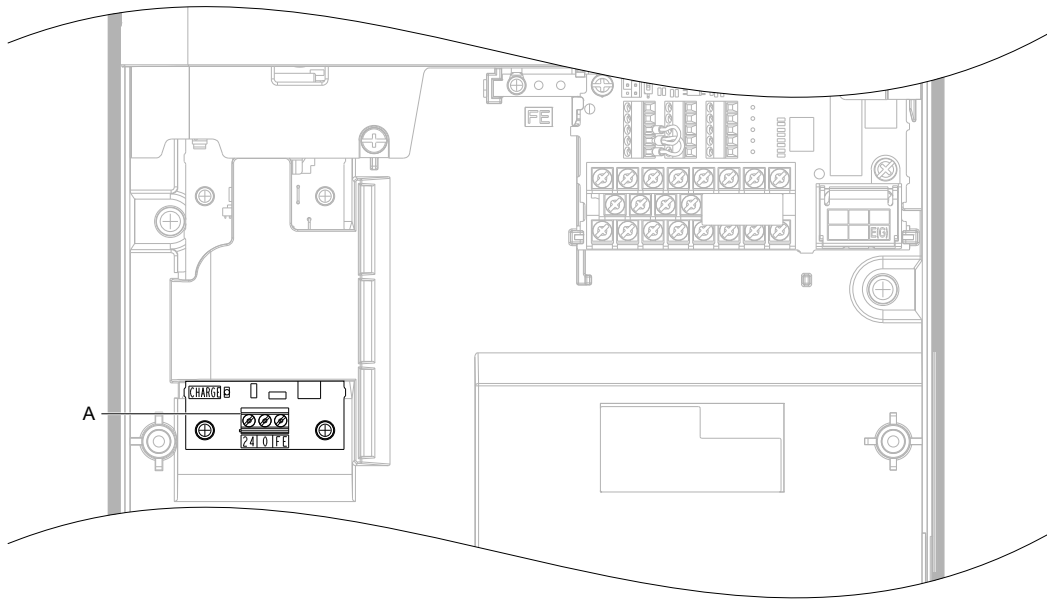
A –Power Supply Terminal Block TB1

Figure i.30 24 V Control Power Supply Unit Location
 (Models 2P0028, 2W0028, 4P0011 to 4P0034, and 4W0011 to 4W0034)

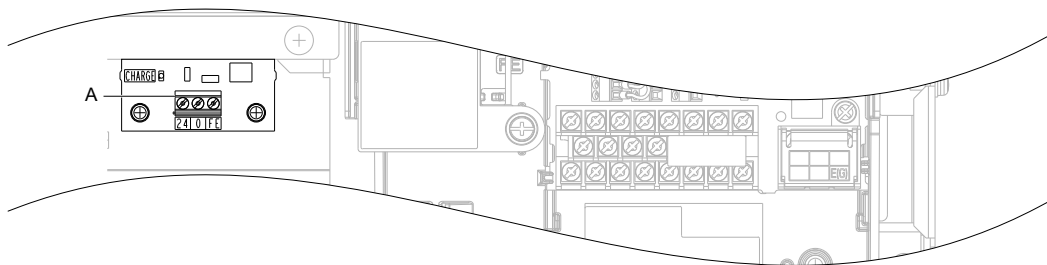


A –Power Supply Terminal Block TB1

**Figure i.31 24 V Control Power Supply Unit Location
(Models 2P0042 to 2P0081, 2W0042 to 2W0081, 4P0040 to 4P0077, and 4W0040 to 4W0077)**

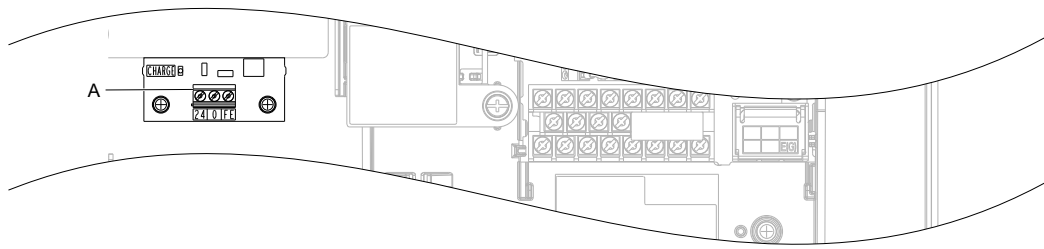


**Figure i.32 24 V Control Power Supply Unit Location
(Models 2P0104, 2W0104, 2P0130, 2W0130, 4P0096, 4W0096, 4P0124, and 4W0124)**



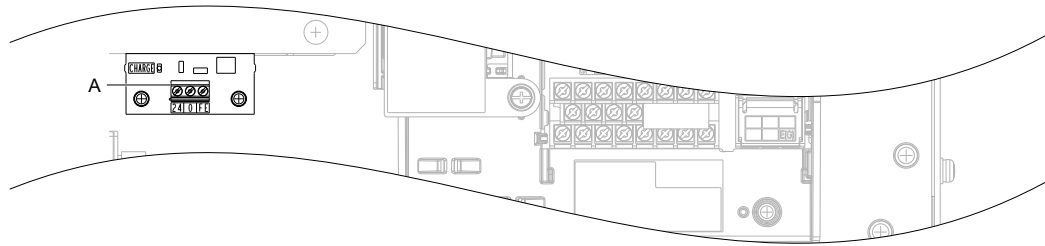
A –Power Supply Terminal Block TB1

**Figure i.33 24 V Control Power Supply Unit Location
(Models 2P0154, 2W0154, 2P0192, 2W0192, 4P0156, 4W0156, 4P0180, and 4W0180)**



A –Power Supply Terminal Block TB1

Figure i.34 24 V Control Power Supply Unit Location
(Models 2P0248, 2W0248, 4P0216, 4W0216, 4P0240, and 4W0240)



A –Power Supply Terminal Block TB1

Figure i.35 24 V Control Power Supply Unit Location
(Models 4P0302 to 4P0414 and 4W0302 to 4W0414)

■ Power Supply Terminal Block TB1 Wiring

Power Supply Terminal Block TB1 Wiring Procedure

1. Select an external power supply.

Two times the normal current will flow through the unit for approximately 0.5 seconds when the 24 V Control Power Supply Unit is first switched on. The unit requires at least 3 A to function properly.

WARNING! *Electrical Shock Hazard.* Use a battery or a double-reinforced UL Class 2 power supply to provide power to the 24 V Control Power Supply Unit. Using a different type of power supply may result in death or serious injury by electrical shock or fire.

NOTICE: Do not install multiple 24 V Control Power Supply Units. Failure could cause erroneous operation or damage the drive.

2. Use a flat-blade screwdriver to loosen the screws on the terminal block TB1, connect wiring to the 24, 0, and FE terminals as shown in [Figure i.36](#), then tighten the terminal screws to hold wiring in place. Refer to [Table i.20](#) to confirm that the proper tightening torque is applied to each terminal. Take particular precaution to ensure that each wire is properly connected and wire insulation is not accidentally pinched into electrical terminals.

NOTICE: Properly connect an external 24 Vdc power source to terminal block TB1. Refer to [Table i.20](#) for details. Improper wiring practices could damage the 24 V Control Power Supply Unit due to incorrect terminal connections.

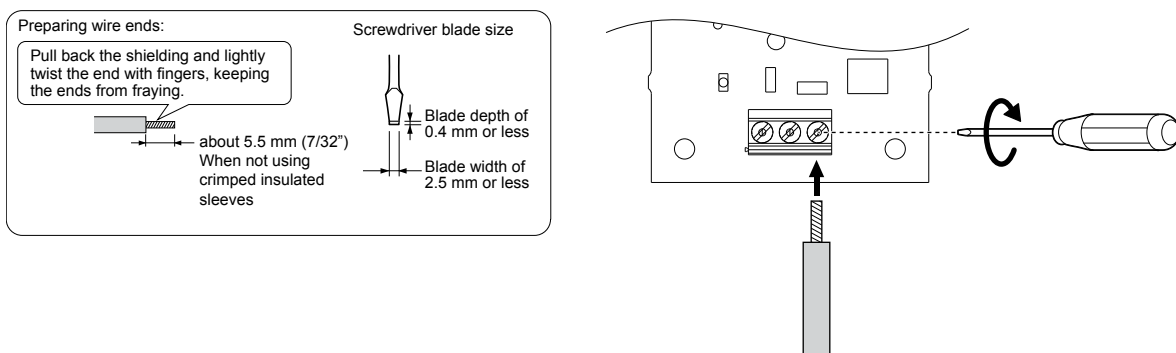


Figure i.36 Wire the Option Plug

WARNING! *Fire Hazard.* Tighten terminal screws to the specified tightening torque. Loose electrical connections could result in death or serious injury by fire due to overheating. Tightening screws beyond the specified tightening torque may cause erroneous operation, damage the terminal block, or cause a fire.

i.4 Electrical Installation

NOTICE: Heat shrink tubing or electrical tape may be required to ensure that cable shielding does not contact other wiring. Insufficient insulation may cause a short circuit and damage the drive.

Tools Required for Installation

A straight-edge screwdriver (blade depth: 0.4 mm, width: 2.5 mm) is required to install the unit and wire the option terminal block.

Note: Tools required to prepare option cables for wiring are not listed in this manual.

Power Supply Terminal Block TB1 Functions

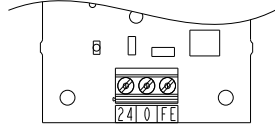


Figure i.37 Power Supply Terminal Block TB1

Table i.19 Power Supply Terminal Block TB1 Functions

Terminal	Function
24	+24 Vdc Input
0	0 V
FE	Ground

Wire Gauges and Tightening Torques

Table i.20 Wire Gauges and Tightening Torques

Terminal	Screw Size	Tightening Torque N·m (in·lb)	Bare Cable		Crimp Terminals		Wire Type
			Recomm. Gauge mm ² (AWG)	Applicable Gauges mm ² (AWG)	Recomm. Gauge mm ² (AWG)	Applicable Gauges mm ² (AWG)	
24, 0, FE	M2	0.22 to 0.25 (1.95 to 2.21)	0.75 (18 AWG)	Stranded wire: 0.25 to 1.0 (24 to 17 AWG) Solid wire: 0.25 to 1.5 (24 to 16 AWG)	0.5 (20 AWG)	0.25 to 0.5 (24 to 20 AWG)	Shielded twisted pair, etc.

Ferrule-Type Wire Terminals

Yaskawa recommends using CRIMPFOX 6, a crimping tool manufactured by PHOENIX CONTACT, to prepare wire ends with insulated sleeves. See [Table i.11](#) for dimensions.

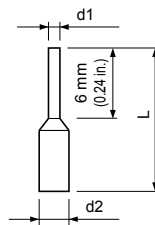


Figure i.38 Ferrule Dimensions

Table i.21 Ferrule Terminal Types and Sizes

Size mm ² (AWG)	Type	L mm (in)	d1 mm (in)	d2 mm (in)	Manufacturer
0.25 (24)	AI 0.25-6YE AI 0.25-6BU	10.5 (0.41)	0.8 (0.03)	2.0 (0.08)	PHOENIX CONTACT
0.34 (22)	AI 0.34-6TQ	10.5 (0.41)	0.8 (0.03)	2.0 (0.08)	
0.5 (20)	AI 0.5-6WH	12 (0.47)	1.1 (0.04)	2.5 (0.10)	

Power Supply and the Control Circuit

[Table i.22](#) outlines the various conditions under which the option provides power to the control circuit.

Table i.22 Power Supply and Control Circuit

Drive Main Circuit Input Power Supply	Power from 24 V Control Power Supply Unit	Control Circuit Operation in Drive	Drive Operation
ON	ON	Operating	Possible
ON	OFF		Possible
OFF	ON		Not possible
OFF	OFF	Stopping	Not possible

UL and CE Compliance

External Power Supply

Use a Class 2 power supply as defined by UL standards for the customer-supplied power supply connection to the 24 V Control Power Supply Unit.

■ 24 V Control Power Supply Unit Specifications

Table i.23 24 V Control Power Supply Unit Specifications

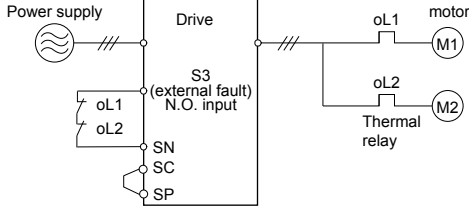
Item	Specifications
Input Operating Voltage	24 Vdc ± 20% (19.2 V to 28.8 V)
Input Current	1.9 A
Consumption Power	38 W
Compliance	UL <1>, CE

<1> Use a Class 2 power supply with a capacity of 24 V to comply with UL standards.

◆ Wiring Checklist

<input checked="" type="checkbox"/>	No.	Item	Page(s)
Drive, Peripherals, Option Cards			
<input type="checkbox"/>	1	Check drive model number to ensure receipt of correct model.	13
<input type="checkbox"/>	2	Make sure you have the correct noise filters and other peripheral devices.	–
<input type="checkbox"/>	3	Check the option card model number.	–
Installation Area and Physical Setup			
<input type="checkbox"/>	4	Ensure that the area surrounding the drive complies with specifications.	15
Power Supply Voltage, Output Voltage			
<input type="checkbox"/>	5	The voltage from the power supply should be within the input voltage specification range of the drive.	–
<input type="checkbox"/>	6	The voltage rating for the motor should match the drive output specifications.	13
<input type="checkbox"/>	7	Verify that the drive is properly sized to run the motor.	
Main Circuit Wiring			
<input type="checkbox"/>	8	Confirm proper branch circuit protection as specified by national and local codes.	–
<input type="checkbox"/>	9	Properly wire the power supply to drive terminals R/L1, S/L2, and T/L3.	22
<input type="checkbox"/>	10	Properly wire the drive and motor together. The motor lines and drive output terminals U/T1, V/T2, and W/T3 should match in order to produce the desired phase order. If the phase order is incorrect, the drive will rotate in the opposite direction.	28
<input type="checkbox"/>	11	Use 600 Vac vinyl-sheathed wire for the power supply and motor lines. Wire gauge recommendations based on using 75 °C (167 °F), 600 Vac vinyl-sheathed wire.	23
<input type="checkbox"/>	12	Use the correct wire gauges for the main circuit. <ul style="list-style-type: none"> Consider the amount of voltage drop when selecting wire gauges. Increase the wire gauge when the voltage drop is greater than 2% of motor rated voltage. Ensure the wire gauge is suitable for the terminal block. Use the following formula to calculate the amount of voltage drop: $\text{Line drop voltage (V)} = \sqrt{3} \times \text{wire resistance } (\Omega/\text{km}) \times \text{wire length (m)} \times \text{current (A)} \times 10^{-3}$ If the cable between the drive and motor exceeds 50 m, adjust the carrier frequency set to C6-02 accordingly. 	23
<input type="checkbox"/>	13	Properly ground the drive.	28
<input type="checkbox"/>	14	Tighten control circuit and grounding terminal screws.	23

i.4 Electrical Installation

<input checked="" type="checkbox"/>	No.	Item	Page(s)
<input type="checkbox"/>	15	Set up overload protection circuits when running multiple motors from a single drive. 	-
<input type="checkbox"/>	16	Verify that ground wiring for models 2E□□□□/2W□□□□/4E□□□□/4W□□□□ is correct before turning on the EMC filter switch.	35
<input type="checkbox"/>	17	Verify phase advancing capacitors, input noise filters, or GFCIs are NOT installed on the output side of the drive.	-
Control Circuit Wiring			
<input type="checkbox"/>	18	Use twisted-pair line for all drive control circuit wiring.	32
<input type="checkbox"/>	19	Ground the shields of shielded wiring to the GND ⊕ terminal.	32
<input type="checkbox"/>	20	For 3-Wire sequence, set parameters for multi-function contact input terminals S1 to S8, and wire control circuits.	-
<input type="checkbox"/>	21	Properly wire the option card.	32
<input type="checkbox"/>	22	Check for any other wiring mistakes. Only use a multimeter to check wiring.	-
<input type="checkbox"/>	23	Properly fasten drive control circuit terminal screws.	23
<input type="checkbox"/>	24	Pick up all wire clippings.	-
<input type="checkbox"/>	25	Ensure that no frayed wires on the terminal block are touching other terminals or connections.	-
<input type="checkbox"/>	26	Properly separate control circuit wiring and main circuit wiring.	-
<input type="checkbox"/>	27	Analog signal line wiring should not exceed 50 m.	-
<input type="checkbox"/>	28	Disconnect the internal EMC filter by moving the SW screw to the OFF position for floating, impedance grounded, or asymmetrically grounded networks.	35

i.5 Start-Up Programming and Operation

Use the HOA keypad to enter OFF commands, switch to AUTO or HAND Mode, change parameters, and display data including fault and alarm information.

◆ HOA Keypad Keys and Displays

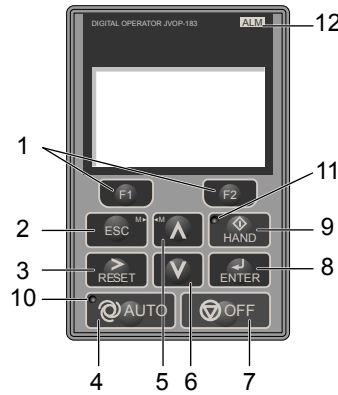


Figure i.39 Keys and Displays on the HOA Keypad

No.	Display	Name	Function
1		Function Key (F1, F2)	The functions assigned to F1 and F2 vary depending on the currently displayed menu. The name of each function appears in the lower half of the display window.
2		ESC Key	<ul style="list-style-type: none"> Returns to the previous display. Moves the cursor one space to the left. Pressing and holding this button will return to the Frequency Reference display.
3		RESET Key	<ul style="list-style-type: none"> Moves the cursor to the right. Resets the drive to clear a fault situation.
4		AUTO Key	<ul style="list-style-type: none"> Selects the source of Run command and frequency reference. Set the drive to AUTO mode. Run command input source depends on b1-02. Frequency reference input source depends on b1-01.
5		Up Arrow Key	Scrolls up to display the next item, selects parameter numbers, and increments setting values.
6		Down Arrow Key	Scrolls down to display the previous item, selects parameter numbers, and decrements setting values.
7		OFF Key	Follows the stopping method set in b1-03 to stop drive operation.
8		ENTER Key	<ul style="list-style-type: none"> Enters parameter values and settings. Selects a menu item to move between displays.
9		HAND Key	<ul style="list-style-type: none"> The drive runs at a selectable frequency reference source by b1-12. Set the drive to HAND mode. When b1-13 is set to 1, HAND and AUTO mode can be switched while the drive is running.
10		AUTO Light	Lit while the drive is in AUTO mode. <i>Refer to AUTO LED and HAND LED Indications on page 47 for details.</i>
11		HAND Light	Lit while the drive is in HAND mode. <i>Refer to AUTO LED and HAND LED Indications on page 47 for details.</i>
12		ALM LED Light	Lit when the drive detects an alarm or error.

◆ LCD Display

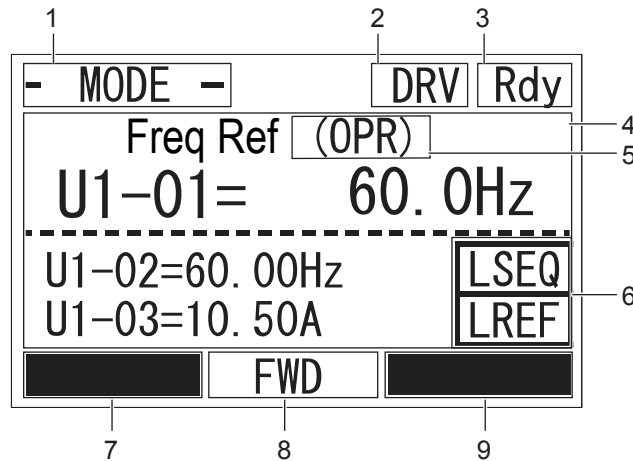












Figure i.40 LCD Display

Table i.24 Display and Contents

No.	Name	Display	Content
1	Operation Mode Menus	MODE	Displayed when in Mode Selection.
		MONITR	Displayed when in Monitor Mode.
		VERIFY	Indicates the Verify Menu.
		PRMSET	Displayed when in Parameter Setting Mode.
		A.TUNE	Displayed during Auto-Tuning.
		SETUP	Displayed when in Setup Mode.
2	Mode Display Area	DRV	Displayed when in Drive Mode.
		PRG	Displayed when in Programming Mode.
3	Ready	Rdy	Indicates the drive is ready to run.
4	Data Display	—	Displays specific data and operation data.
5	Frequency Reference Assignment </>	OPR	Displayed when the frequency reference is assigned to the HOA keypad.
		AI	Displayed when the frequency reference is assigned to the Analog Input of the drive.
		COM	Displayed when the frequency reference is assigned to the MEMOBUS/Modbus Communication Inputs of the drive.
		OP	Displayed when the frequency reference is assigned to an option card connected to the drive.
6	LO/RE Display </>	RSEQ	Displayed when the run command is supplied from a remote source.
		LSEQ	Displayed when the run command is supplied from the operator keypad.
		RREF	Displayed when the frequency reference is supplied from a remote source.
		LREF	Displayed when the frequency reference is supplied from the operator keypad.
7	Function Key 1 (F1)	JOG	Pressing  runs the motor at the Jog frequency.
		HELP	Pressing  displays the Help menu.
		←	Pressing  scrolls the cursor to the left.
		HOME	Pressing  returns to the top menu (Frequency Reference).
		ESC	Pressing  returns to the previous display.
8	FWD/REV	FWD	Indicates forward motor operation.
		REV	Indicates reverse motor operation.















No.	Name	Display	Content
9	Function Key 2 (F2)	FWD/REV	Pressing  switches between forward and reverse.
		DATA	Pressing  scrolls to the next display.
		→	Pressing  scrolls the cursor to the right.
		RESET	Pressing  resets the existing drive fault error.
		Monitor	Pressing  switches Monitor mode.
		DRV/BYP	The multi-function relay selected Drive/Bypass contact will be toggled.
		RUNBYP	The multi-function relay selected to RUN Bypass will be toggled.
		RLY	The multi-function relay selected to Relay operator control will be toggled.

<1> Displayed when in Frequency Reference Mode.

<2> Displayed when in Frequency Reference Mode and Monitor Mode.

◆ AUTO LED and HAND LED Indications

Table i.25 AUTO LED and HAND LED Indications

AUTO LED	HAND LED	State
 Off	 Off	OFF mode
 Off	 On solid	HAND mode
 Off	 Long blink (50% duty)	HAND mode when the Frequency Reference is 0 and/or decelerating in HAND mode.
 On solid	 Off	Running in AUTO mode
 Long blink (50% duty)	 Off	Running in AUTO mode when the Frequency Reference is 0 and/or decelerating in AUTO mode.
 Short blink (15% duty)	 Off	AUTO mode, Ready, No run command input.
 Double blink	 Off	AUTO mode, stopped by a Fast- Stop from a Multi-Function Digital Input.

◆ Menu Structure for HOA Keypad

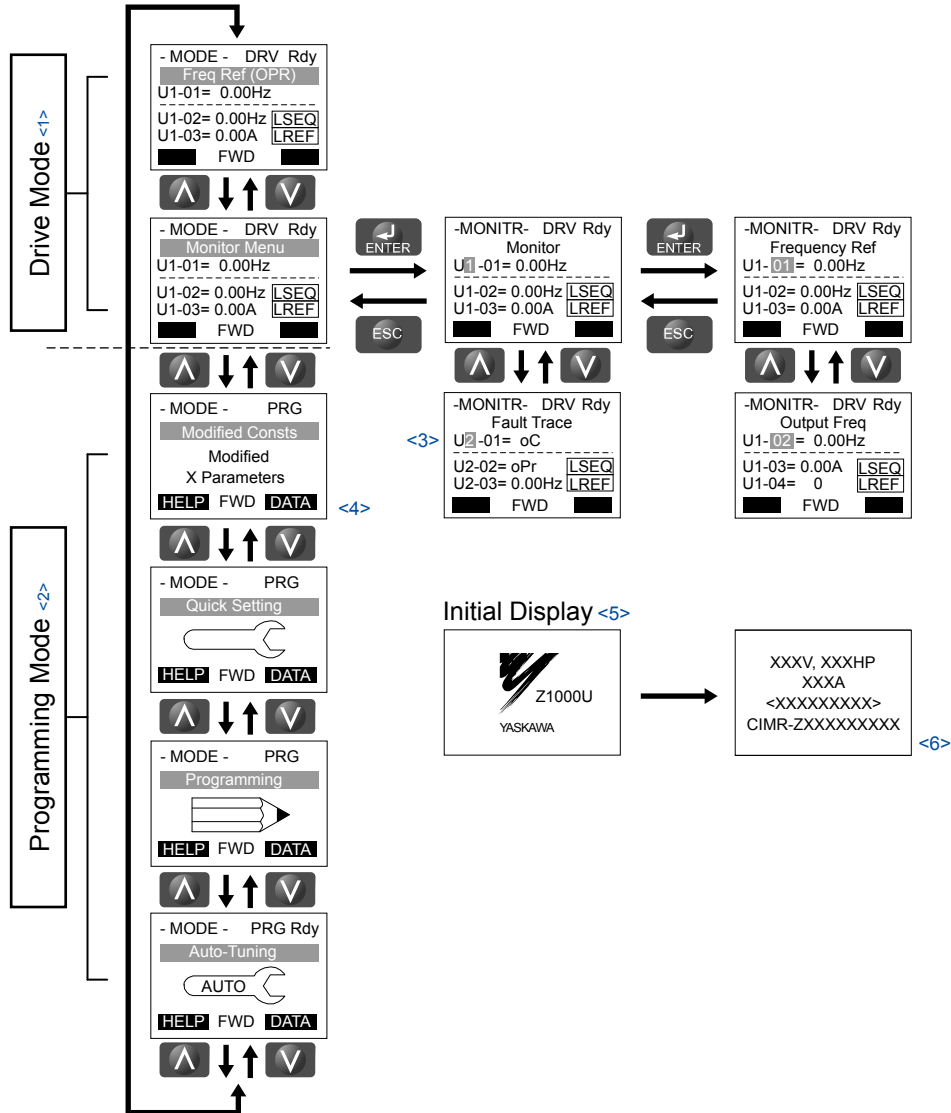




Figure i.41 HOA Keypad Menu and Screen Structure

- <1> Pressing  or  will start the motor.
- <2> Drive cannot operate motor.
- <3> Flashing characters are shown with white letters on gray background. (Example: **0**)
- <4> "X" characters are used as examples in this manual. The HOA keypad will display the actual setting values.
- <5> The Frequency Reference appears after the initial display that shows the product name.
- <6> The information that appears on the display will vary depending on the drive.

◆ Basic Start-Up and Motor Tuning Flowchart

The flowchart shown in *Figure i.42* describes a basic start-up sequence that varies slightly depending on the application. Use the drive default parameter settings in simple applications that do not require high precision.

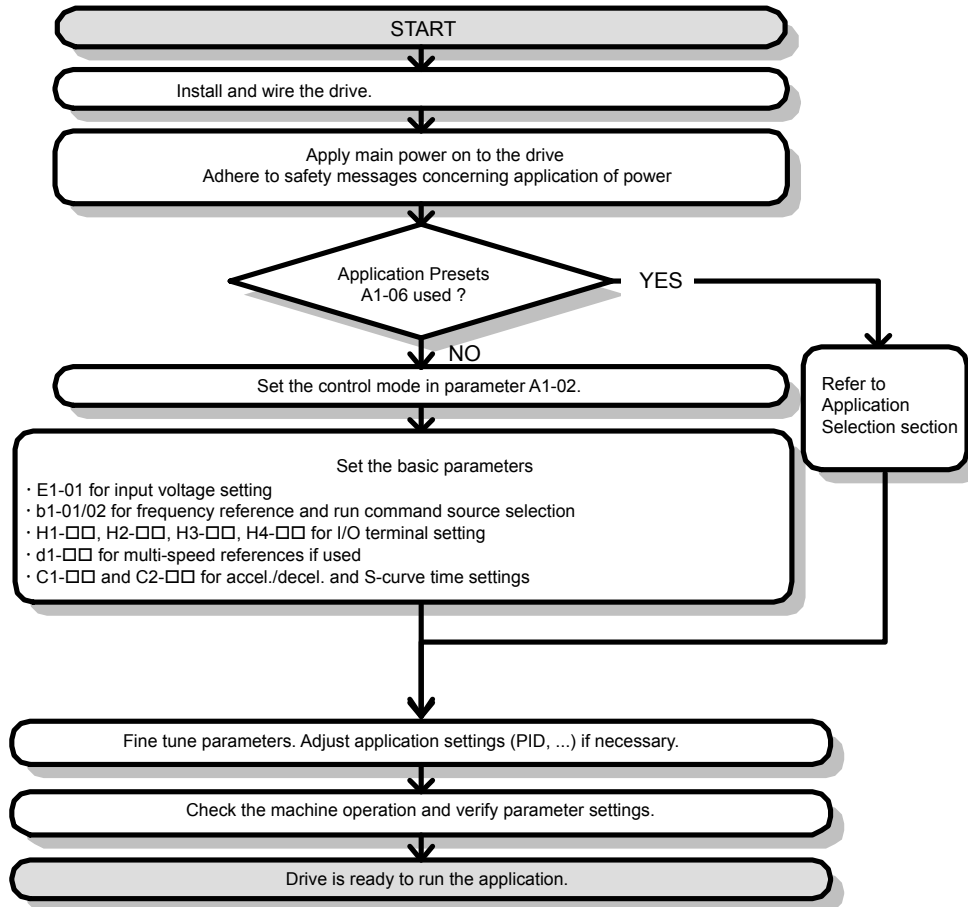


Figure i.42 Basic Start-Up

■ Powering Up the Drive

Review the following checklist before turning the power on.

Item to Check	Description
Power supply voltage	200 V class: Three-phase 200 to 240 Vac 50/60 Hz 400 V class: Models 4U□□□□ and 4P□□□□: Three-phase 380 to 500 Vac 50/60 Hz 400 V class: Models 4E□□□□ and 4W□□□□: Three-phase 380 to 480 Vac 50/60 Hz
	Properly wire the power supply input terminals (R/L1, S/L2, T/L3).
	Check for proper grounding of drive and motor. Use a power supply with a capacity that is equal to or greater than drive capacity.
Drive output terminals and motor terminals	Properly wire drive output terminals U/T1, V/T2, and W/T3 with motor terminals U, V, and W.
Control circuit terminals	Check control circuit terminal connections.
Drive control terminal status	Open all control circuit terminals (off).
Status of the load and connected machinery	Decouple the motor from the load.

◆ Basic Drive Setup Adjustments

■ A1-02: Control Method Selection

Selects the Control Method (also referred to as the control mode) that the drive uses to operate the motor. Parameter A1-02 determines the control mode for the motor.

Note: When changing control modes, all parameter settings depending upon the setting of A1-02 will be reset to the default.

No.	Parameter Name	Setting Range	Default
A1-02	Control Method Selection	0, 5	0

Setting 0: V/f Control for Induction Motors

Use this mode for simple speed control and for multiple motor applications with low demands to dynamic response or speed accuracy. The speed control range is 1:40.

Setting 5: Open Loop Vector Control for PM

Use this mode when running a PM motor in variable torque applications that benefit from energy efficiency. The drive can control an SPM or IPM motor with a speed range of 1:20 in this control mode.

■ A1-03: Initialize Parameters

Resets parameters to default values. After initialization, the setting for A1-03 automatically returns to 0.

No.	Parameter Name	Setting Range	Default
A1-03	Initialize Parameters	0, 1110, 2220, 3330, 3410, 3420	0

Setting 0: No Initialize

Setting 1110: User Initialize

Resets parameters to the values selected by the user as User Settings. User Settings are stored when parameter o2-03 is set to “1: Set defaults”.

Note: User Initialization resets all parameters to a user-defined set of default values previously saved to the drive. Set parameter o2-03 to 2 to clear the user-defined default values.

Setting 2220: 2-Wire Initialization

Resets parameters except parameters listed in [Table i.26](#) to default settings with digital inputs S1 and S2 configured as Forward run and Reverse run, respectively.

Setting 3330: 3-Wire Initialization

Resets parameters to default settings with digital inputs S1, S2, and S5 configured as Run, Stop, and Forward/Reverse respectively.

Setting 3410: HVAC Initialization

Resets parameters to default settings. The following parameters are not reset:

H1-03: b1 (Customer Safeties)

H1-04: b2 (BAS Interlock)

H1-05: AF (Emergency Override Forward Run)

H2-03: b2 (BAS Interlock Relay Contact)

Note: After performing an HVAC Initialization, H1-03 to H1-05 and H2-03 will be displayed in the Modified Parameters list.

Setting 3420: OEM Bypass Initialization

Resets parameters to default settings. The following parameters are not reset:

H1-03: A7 (BP Customer Safeties)

H1-04: A6 (BP BAS Interlock)

H1-05: A4 (Emergency Override)

H1-06: AE (BP Bypass Run)

H2-01: A4 (BP Drive Relay)

H2-02: A5 (BP Bypass Relay)

H2-03: A6 (BP BAS Interlock)

o1-16: 2 (Drive/Bypass)

Note: After performing an OEM Bypass Initialization, H1-03 to H1-05, H2-01 to H2-03, and o1-16 will be displayed in the Modified Parameters list.

Notes on Parameter Initialization

The parameters shown in [Table i.26](#) will not be reset when the drive is initialized by setting A1-03 = 2220 or 3330. Although the control mode in A1-02 is not reset when A1-03 is set to 2220 or 3330, it may change when an application preset is selected.

Table i.26 Parameters Not Changed by Drive Initialization

No.	Parameter Name
A1-00	Language Selection
A1-02	Control Method Selection
E1-03	V/f Pattern Selection
F6-08	Communication Parameter Reset
L8-35	Installation Selection
o2-04	Drive Model Selection

■ b1-01: Frequency Reference Selection for AUTO Mode

Selects the frequency reference source 1.

Note: If a Run command is input to the drive, but the frequency reference entered is 0 or below the minimum frequency, the AUTO or HAND indicator LED on the HOA keypad will light and the OFF indicator will flash.

No.	Parameter Name	Setting Range	Default
b1-01	Frequency Reference Selection for AUTO Mode	0 to 3	1

Setting 0: HOA Keypad

Using this setting, the frequency reference can be input using the HOA keypad.

Setting 1: Terminals (analog input terminals)

Using this setting, an analog frequency reference can be entered as a voltage or current signal from terminals A1, A2, or A3.

Voltage Input

Voltage input can be used at any of the three analog input terminals. Make the settings as described in [Table i.27](#) for the input used.

Table i.27 Analog Input Settings for Frequency Reference Using Voltage Signals

Terminal	Signal Level	Parameter Settings				Notes
		Signal Level Selection	Function Selection	Gain	Bias	
A1	0 to 10 Vdc	H3-01 = 0	H3-02 = 0 (Frequency Reference Bias)	H3-03	H3-04	-
	-10 to +10 Vdc	H3-01 = 1				
A2	0 to 10 Vdc	H3-09 = 0	H3-10 = 0 (Frequency Reference Bias)	H3-11	H3-12	Set jumper S1 on the terminal board to “V” for voltage input.
	-10 to +10 Vdc	H3-09 = 1				
A3	0 to 10 Vdc	H3-05 = 0	H3-06 = 0 (Frequency Reference Bias)	H3-07	H3-08	Set DIP switch S4 on the terminal board to “AI”.
	-10 to +10 Vdc	H3-05 = 1				

i.5 Start-Up Programming and Operation

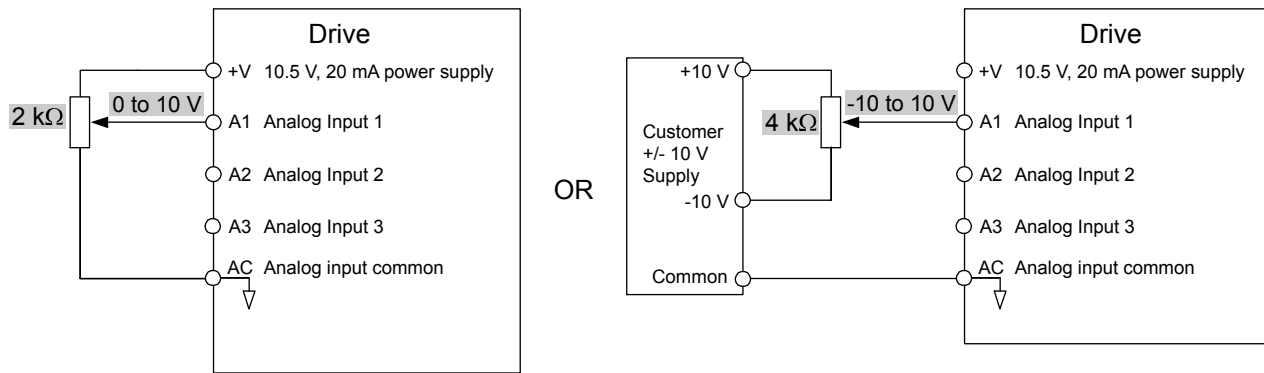


Figure i.43 Setting the Frequency Reference as a Voltage Signal at Terminal A1

Current Input

Input terminals, A1, A2, and A3 can accept a current input signal. Refer to [Table i.28](#) for an example to set terminal A2 for current input.

Table i.28 Analog Input Settings for Frequency Reference Using a Current Signal

Terminal	Signal Level	Parameter Settings				Notes
		Signal Level Selection	Function Selection	Gain	Bias	
A2	4 to 20 mA	H3-09 = 2	H3-10 = 0 (Frequency Bias)	H3-11	H3-12	Make sure to set jumper S1 on the terminal board to "I" for current input.
	0 to 20 mA	H3-09 = 3				

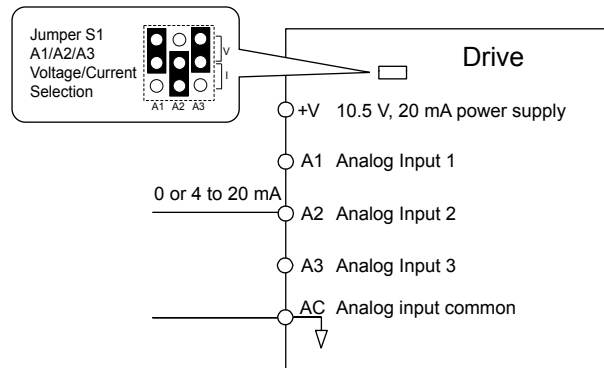


Figure i.44 Setting the Frequency Reference as a Current Signal to Terminal A2

Switching between Main/Auxiliary Frequency References

The frequency reference input can be switched between the analog terminals A1, A2, and A3 using multi-speed inputs. [Refer to Multi-Step Speed Selection on page 56](#) for details on using this function.

Setting 2: Serial Communication (APOGEE FLN, BACnet, MEMOBUS/Modbus, Metasys N2)

This setting requires entering the frequency reference via the RS-422/RS-485 serial communications port (control terminals R+, R-, S+, and S-).

Setting 3: Option card

This setting requires entering the frequency reference via an option board plugged into connector CN5-A on the drive control board. Consult the option board manual for instructions on integrating the drive with the communication system.

Note: If the frequency reference source is set for Option PCB (b1-01 = 3), but an option board is not installed, an oPE05 operation error will be displayed on the digital operator and the drive will not run.

■ b1-02: Run Command Selection for AUTO Mode

Determines the Run command selection for AUTO mode.

No.	Parameter Name	Setting Range	Default
b1-02	Run Command Selection for AUTO Mode	1 to 3	1

Setting 1: Control Circuit Terminal

This setting requires entering the Run command via the digital input terminals using one of following sequences:

- 2-Wire sequence 1:
Two inputs (FWD/Stop-REV/Stop). Set A1-03 to 2220 to initialize the drive and preset terminals S1 and S2 to these functions. This is the default setting of the drive.
- 2-Wire sequence 2:
Two inputs (Start/Stop-FWD/REV).
- 3-Wire sequence:
Three inputs (Start-Stop-FWD/REV). Set A1-03 to 3330 to initialize the drive and preset terminals S1, S2, and S5 to these functions.

Setting 2: Serial Communication (APOGEE FLN, BACnet, MEMOBUS/Modbus, Metasys N2)

This setting requires entering the Run command via serial communications by connecting the RS-422/RS-485 serial communication cable to control terminals R+, R-, S+, and S- on the terminal block.

Setting 3: Option Card

This setting requires entering the Run command via the communication option board by plugging a communication option board into the CN5 port on the control PCB. Refer to the option card manual for instructions on integrating the drive into the communication system.

Note: If b1-02 is set to 3, but an option card is not installed in CN5, an oPE05 operation error will be displayed on the HOA keypad and the drive will not run.

■ b1-03: Stopping Method Selection

Selects how the drive stops the motor when the Run command is removed or when a Stop command is entered.

No.	Parameter Name	Setting Range	Default
b1-03	Stopping Method Selection	0 to 3	1

Setting 0: Ramp to Stop

When the Run command is removed, the drive will decelerate the motor to stop. The deceleration rate is determined by the active deceleration time. The default deceleration time is set to parameter C1-02.

When the output frequency falls below the level set in parameter b2-01, the drive will start DC injection or Short Circuit Braking depending on the selected control mode.

Setting 1: Coast to Stop

When the Run command is removed, the drive will shut off its output and the motor will coast (uncontrolled deceleration) to stop. The stopping time is determined by the inertia and the friction in the driven system.

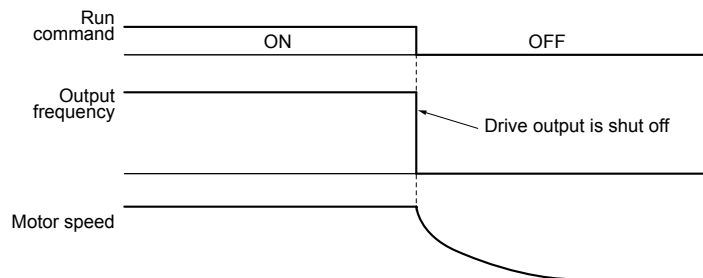


Figure i.45 Coast to Stop

Setting 2: DC Injection Braking to Stop

When the Run command is removed, the drive will enter baseblock (turn off its output) for the minimum baseblock time (L2-03). When the minimum baseblock time has expired, the drive will inject the amount DC current set in parameter b2-02 into the motor windings to brake the motor. The stopping time in DC Injection Braking to Stop is significantly faster compared to Coast to Stop.

Note: This function is not available in OLV/PM control mode (A1-02 = 5).

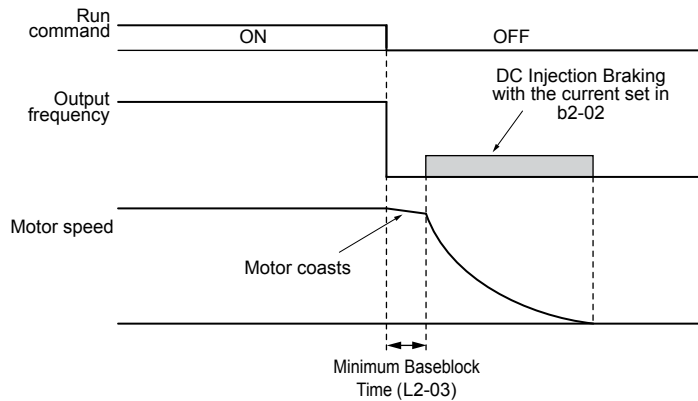


Figure i.46 DC Injection Braking to Stop

DC Injection Braking time is determined by the value set to b2-04 and the output frequency at the time the Run command is removed. It can be calculated by:

$$\text{DC Injection brake time} = \frac{(b2-04) \times 10 \times \text{Output frequency}}{\text{Maximum output frequency (E1-04)}}$$

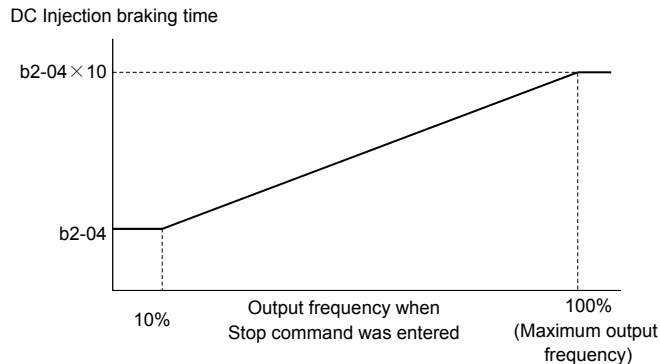


Figure i.47 DC Injection Braking Time Depending on Output Frequency

Note: If an overcurrent (oC) fault occurs during DC Injection Braking to Stop, lengthen the minimum baseblock time (L2-03) until the fault no longer occurs.

Setting 3: Coast with Timer

When the Run command is removed, the drive will turn off its output and the motor will coast to stop. The drive will not start if a Run command is input before the time t (C1-02) has expired. Cycle the Run command that was activated during time t after t has expired to start the drive.

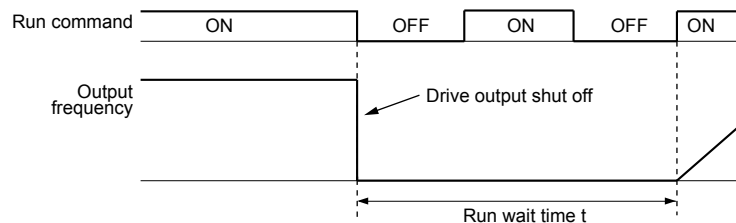


Figure i.48 Coast with Timer

The wait time t is determined by the output frequency when the Run command is removed and by the active deceleration time.

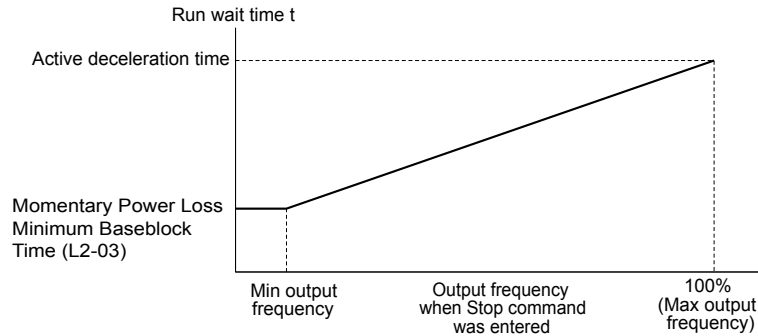


Figure i.49 Run Wait Time Depending on Output Frequency

■ **b1-04: Reverse Operation Selection**

Enables and disables Reverse operation. For some applications, reverse motor rotation is not appropriate and may cause problems (e.g., air handling units, pumps, etc.).

No.	Parameter Name	Setting Range	Default
b1-04	Reverse Operation Selection	0, 1	1

Setting 0: Reverse Enabled

Possible to operate the motor in both forward and reverse directions.

Setting 1: Reverse Disabled

Drive disregards a Reverse run command or a negative frequency reference.

■ **C1-01 to C1-04: Accel, Decel Times 1 and 2**

Two different sets of acceleration and deceleration times can be set in the drive by digital inputs, motor selection, or switched automatically.

Acceleration time parameters always set the time to accelerate from 0 Hz to the maximum output frequency (E1-04). Deceleration time parameters always set the time to decelerate from maximum output frequency to 0 Hz. C1-01 and C1-02 are the default active accel/decel settings.

No.	Parameter Name	Setting Range	Default
C1-01	Acceleration Time 1	0.0 to 6000.0 s ^{<1>}	10.0 s
C1-02	Deceleration Time 1		
C1-03	Acceleration Time 2		
C1-04	Deceleration Time 2		

<1> The setting range for the acceleration and deceleration times is determined by the accel/decel time setting units in C1-10. For example, if the time is set in units of 0.01 s (C1-10 = 0), the setting range becomes 0.00 to 600.00 s.

Switching Acceleration Times by Digital Input

Accel/decel time 1 is active by default if no input is set. Activate accel/decel times 2, 3, and 4 by digital inputs (H1-□□ = 7 and 1A) as explained in [Table i.29](#).

Table i.29 Accel/Decel Time Selection by Digital Input

Accel/Decel Time Sel. 1 H1-□□ = 7	Accel/Decel Time Sel. 2 H1-□□ = 1A	Active Times	
		Acceleration	Deceleration
0	0	C1-01	C1-02
1	0	C1-03	C1-04

Figure i.50 shows an operation example for changing accel/decel. times. The example below requires that the stopping method be set for “Ramp to stop” (b1-03 = 0).

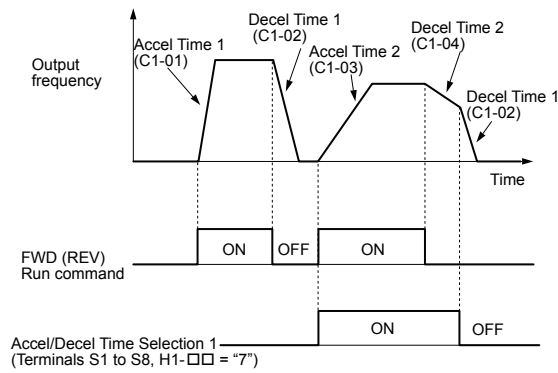


Figure i.50 Timing Diagram of Accel/Decel Time Change

■ C7-60: Output Voltage Limit Mode Selection

Sets the mode to limit the output voltage.

Set this parameter to 0 (Harmonic suppression priority mode) to give priority to harmonic suppression. The maximum output voltage is automatically limited to suppress harmonics.

Set this parameter to 1 (High output voltage mode) to give priority to the output voltage over harmonic suppression. The effectiveness of harmonic suppression will be reduced because the maximum output voltage will be used.

Note: For drives with software versions PRG: 1021 or later, the default setting is 0 (Harmonic Suppression Priority Mode) when in Advanced Open Loop Vector Control for PM (A1-02 = 6).

No.	Parameter Name	Setting Range	Default
C7-60	Output Voltage Limit Mode Selection	0, 1	Determined by A1-02

Setting 0: Harmonic Suppression Priority Mode

Setting 1: High Output Voltage Mode

■ d1-01 to d1-04, d1-16, and d1-17: Frequency References 1 to 4, 16, and Jog Frequency Reference

The drive lets the user switch between up to 5 preset frequency references during run (including the Jog reference) through the digital input terminals. The drive uses the acceleration and deceleration times that have been selected when switching between each frequency reference.

The Jog frequency overrides all other frequency references and must be selected by a separate digital input.

The multi-speed references 1 and 2 can be provided by analog inputs.

No.	Parameter Name	Setting Range	Default
d1-01 to d1-04	Frequency Reference 1 to 4	0.00 to 400.00 Hz <> <>	0.00 Hz <>
d1-16	Frequency Reference 16	0.00 to 400.00 Hz <> <>	0.00 Hz <>
d1-17	Jog Frequency Reference	0.00 to 400.00 Hz <> <>	6.00 Hz <>

<1> The upper limit is determined by the maximum output frequency (E1-04) and upper limit for the frequency reference (d2-01).

<2> Setting units are determined by parameter o1-03. The default is "Hz" (o1-03 = 0).

Multi-Step Speed Selection

To use several speed references for a multi-step speed sequence, set the H1-□□ parameters to 3 and 4. To assign the Jog reference to a digital input, set H1-□□ to 6.

Notes on using analog inputs as Multi-Speed 1 and 2:

- The first frequency reference (Multi-Speed 1) comes from the source specified in b1-01. When using an analog input terminal to supply the frequency reference, assign the frequency reference source to the control terminals (b1-01 = 1).
- When an analog input is set to "Auxiliary frequency 1" (H3-02 or H2-06 = 2), the value set to this input will be used as the Multi-Step Speed 2 instead of the value set to parameter d1-02. If no analog inputs are set for "Auxiliary frequency 1", then d1-02 becomes the reference for Multi-Step Speed 2.

Select the different speed references as shown in [Table i.30](#). [Figure i.51](#) illustrates the multi-step speed selection.

Table i.30 Multi-Step Speed Reference and Terminal Switch Combinations

Reference	Multi-Step Speed H1-□□ = 3	Multi-Step Speed 2 H1-□□ = 4	Jog Reference H1-□□ = 6
Frequency Reference 1 (set in b1-01)	OFF	OFF	OFF
Frequency Reference 2 (d1-02 or input terminal A1, A2)	ON	OFF	OFF
Frequency Reference 3 (d1-03 or input terminal A1, A2)	OFF	ON	OFF
Frequency Reference 4 (d1-04)	ON	ON	OFF
Jog Frequency Reference (d1-17) <1>	–	–	ON

<1> The Jog frequency overrides all other frequency references.

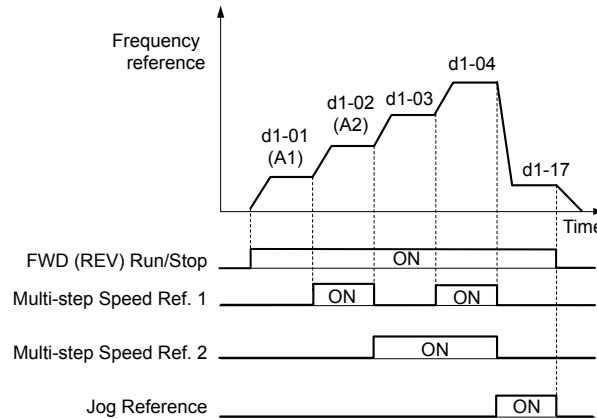


Figure i.51 Preset Reference Timing Diagram

■ d2-01: Frequency Reference Upper Limit

Sets the maximum frequency reference as a percentage of the maximum output frequency. This limit applies to all frequency references.

Even if the frequency reference is set to a higher value, the drive internal frequency reference will not exceed this value.

No.	Parameter Name	Setting Range	Default
d2-01	Frequency Reference Upper Limit	0.0 to 110.0%	100.0%

■ d2-02: Frequency Reference Lower Limit

Sets the minimum frequency reference as a percentage of the maximum output frequency. This limit applies to all frequency references.

If a lower reference than this value is entered, the drive will run at the limit set to d2-02. If the drive is started with a lower reference than d2-02, it will accelerate up to d2-02.

No.	Parameter Name	Setting Range	Default
d2-02	Frequency Reference Lower Limit	0.0 to 110.0%	0.0%

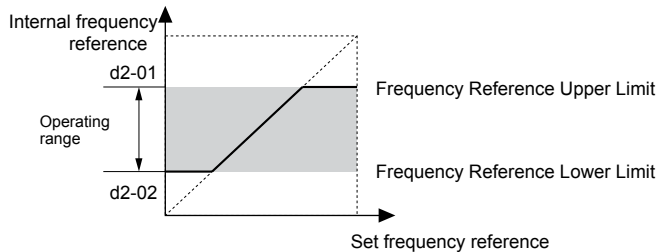


Figure i.52 Frequency Reference: Upper and Lower Limits

i.5 Start-Up Programming and Operation

■ E2-01: Motor Rated Current

Provides motor control, protects the motor, and calculates torque limits. Set E2-01 to the full load amps (FLA) stamped on the motor nameplate. If Auto-Tuning completes successfully, the value entered to T1-04 will automatically be saved to E2-01.

No.	Parameter Name	Setting Range	Default
E2-01	Motor Rated Current	10% to 150% of the drive rated current </>	Determined by o2-04

<1> Display is in the following units:

2□0028, 2□0042, and 4□0011 to 4□0027: 0.01 A units

2□0054 to 2□0248 and 4□0034 to 4□0414: 0.1 A units

Note: Setting E2-01 ≤ E2-03 will trigger an oPE02 error. Set E2-03 correctly to prevent this error.

■ H1-01 to H1-08: Functions for Terminals S1 to S8

No.	Parameter Name	Setting Range	Default
H1-01	Multi-Function Digital Input Terminal S1 Function Selection	1 to 9F	40 (F) </> : Forward Run Command (2-Wire sequence)
H1-02	Multi-Function Digital Input Terminal S2 Function Selection	1 to 9F	41 (F) </> : Reverse Run Command (2-Wire sequence)
H1-03	Multi-Function Digital Input Terminal S3 Function Selection	0 to 9F	24: External Fault (N.O., always detected, coast to stop)
H1-04	Multi-Function Digital Input Terminal S4 Function Selection	0 to 9F	14: Fault Reset
H1-05	Multi-Function Digital Input Terminal S5 Function Selection	0 to 9F	3 (0) </> : Multi-Step Speed Reference 1
H1-06	Multi-Function Digital Input Terminal S6 Function Selection	0 to 9F	4 (3) </> : Multi-Step Speed Reference 2
H1-07	Multi-Function Digital Input Terminal S7 Function Selection	0 to 9F	6 (4) </> : Jog Reference Selection
H1-08	Multi-Function Digital Input Terminal S8 Function Selection	0 to 9F	8: External Baseblock Command

<1> Number appearing in parenthesis is the default value after performing a 3-Wire initialization (A1-03 = 3330).

■ H2-01 to H2-03: Terminal M1-M2, M3-M4, and MD-ME-MF Function Selection

No.	Parameter Name	Setting Range	Default
H2-01	Terminal M1-M2 Function Selection (relay)	0 to 1B6	0: During Run
H2-02	Terminal M3-M4 Function Selection (relay)	0 to 1B6	1: Zero Speed
H2-03	Terminal MD-ME-MF Function Selection (relay)	0 to 1B6	2: Speed agree 1

■ L1-01: Motor Overload Protection Selection

The drive has an electronic overload protection function that estimates the motor overload level based on output current, output frequency, thermal motor characteristics, and time. When the drive detects a motor overload an oL1 fault is triggered and the drive output shuts off.

L1-01 sets the overload protection function characteristics according to the motor being used.

No.	Name	Setting Range	Default
L1-01	Motor Overload Protection Selection	0, 1, 4	Determined by A1-02

- Note:**
1. When the motor protection function is enabled (L1-01 ≠ 0), an oL1 alarm can be output through one of the multi-function outputs by setting H2-01 to 1F. The output closes when the motor overload level reaches 90% of the oL1 detection level.
 2. Set L1-01 to a value between 1 and 6 when running a single motor from the drive to select a method to protect the motor from overheat. An external thermal relay is not necessary.

Setting 0: Disabled (Motor Overload Protection Is Not Provided)

Use this setting if no motor overheat protection is desired or if multiple motors are connected to a single drive. If multiple motors are connected to a single drive, install a thermal relay for each motor as shown in [Figure i.53](#).

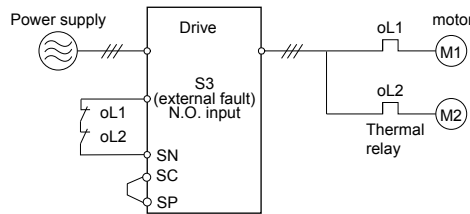


Figure i.53 Example of Protection Circuit Design for Multiple Motors

NOTICE: Thermal protection cannot be provided when running multi-motors simultaneously with the same drive, or when using motors with a relatively high current rating compared to other standard motors (such as a submersible motor). Failure to comply could result in motor damage. Disable the electronic overload protection of the drive (L1-01 = "0: Disabled") and protect each motor with individual motor thermal overloads.

Note: Close MC1 and MC2 before operating the drive. MC1 and MC2 cannot be switched off during run.

Setting 1: General-purpose Motor (Standard Self-cooled)

Because the motor is self-cooled, the overload tolerance drops when the motor speed is lowered. The drive appropriately adjusts the electrothermal trigger point according to the motor overload characteristics, protecting the motor from overheat throughout the entire speed range.

Overload Tolerance	Cooling Ability	Overload Characteristics
	<p>Motor designed to operate from line power. Motor cooling is most effective when running at rated base frequency (check the motor nameplate or specifications).</p>	<p>Continuous operation at less than line power frequency with 100% load can trigger a motor overload fault (oL1). A fault is output and the motor will coast to stop.</p>

Setting 4: PM Derated Torque Motor

Use this setting when operating a PM motor. PM motors for derated torque have a self-cooling design and the overload tolerance drops as the motor slows. Electronic thermal overload is triggered in accordance with the motor overload characteristics, providing overheat protection across the entire speed range.

Overload Tolerance	Cooling Ability	Overload Characteristics
	<p>Motor is designed to produce 100% torque at base speed. Built with effective cooling capabilities.</p>	<p>Reaching 100% when operating at below the base frequency causes a motor overload fault (oL1). The drive fault output closes and the motor coasts to stop.</p>

■ L1-02: Motor Overload Protection Time

Sets the time for the drive to shut down on motor overload (oL1) when the motor is running with excessive current. Enter the time the motor can withstand operating at 150% current after previously running at 100% current (hot motor overload condition). There is normally no need to change this parameter from the default value.

No.	Name	Setting Range	Default
L1-02	Motor Overload Protection Time	0.1 to 5.0 minutes	1.0 minutes

Defaulted to operate with an allowance of 150% overload operation for one minute in a hot start after continuous operation at 100%.

Figure i.54 illustrates an example of the electrothermal protection operation time using a general-purpose motor operating at the value of E1-06, Motor Base Speed, with L1-02 set to one minute.

i.5 Start-Up Programming and Operation

Motor overload protection operates in the area between a cold start and a hot start.

- Cold start: Characteristics of motor protection operation time in response to an overload situation that was suddenly reached when starting a stationary motor.
- Hot start: Characteristics of motor protection operation time in response to an overload situation that occurred while the motor was operating continuously at or below its rated current.

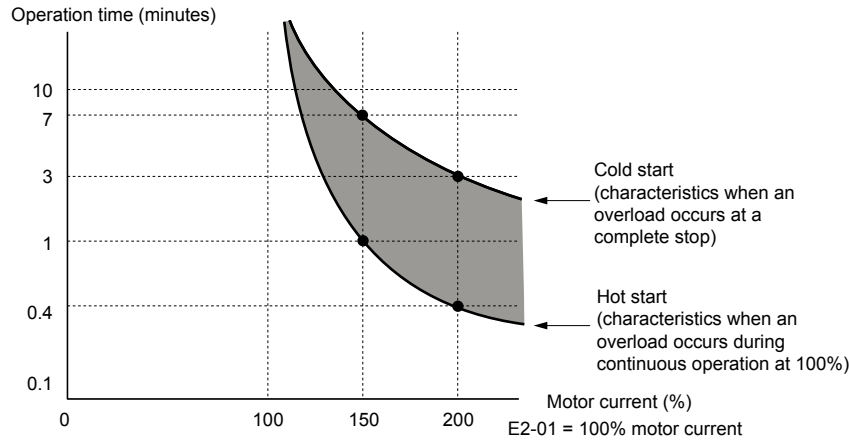


Figure i.54 Protection Operation Time for General Purpose Motors at the Rated Output Frequency

■ Motor Protection Using a Positive Temperature Coefficient (PTC) Thermistor

Connect a motor PTC can to an analog input of the drive for motor overheat protection.

The motor overheat alarm level triggers an oH3 alarm and the drive continues the operation selected in L1-03. The overheat fault level triggers an oH4 fault, outputs a fault signal, and the drive stops the motor using the stop method selected in L1-04.

Connect the PTC between terminals AC and A3 and install a 12 kOhm resistor between terminals V+ and A3 as shown in [Figure i.55](#). Set H3-05 to 0 and H3-06 to E.

Note: A 12 kOhm resistor must be connected between one of the terminals A1, A2, or A3 and V+ for PTC functionality. Connect the 12 kOhm resistor to the same terminal as the PTC input. Do not connect terminals V+ to AC, or damage to the drive may result.

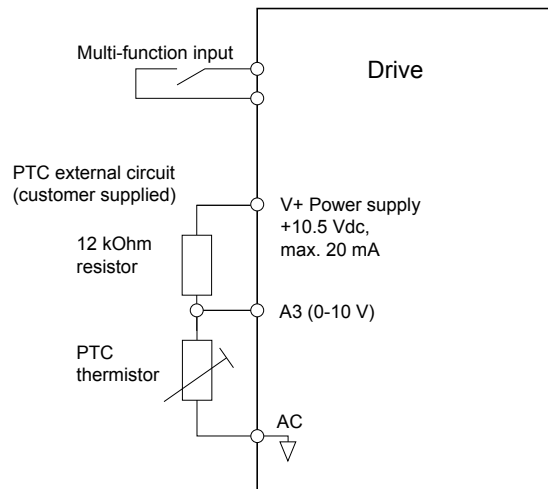


Figure i.55 Connection of a Motor PTC

The PTC must exhibit the characteristics shown in [Figure i.56](#) in one motor phase. The motor overload protection of the drive expects 3 of these PTCs to be connected in a series.

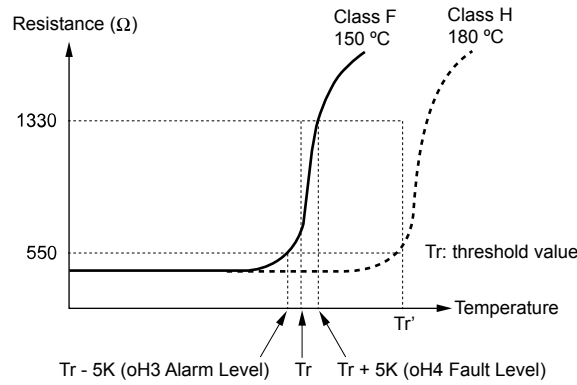


Figure i.56 Motor PTC Characteristics

Set up overheat detection using a PTC using parameters L1-03, L1-04, and L1-05 as explained in the following sections.

◆ Auto-Tuning

The drive offers different types of Auto-Tuning for induction motors and permanent magnet motors. The type of Auto-Tuning used differs further based on the control mode and other operating conditions. Refer to the tables below to select the type of Auto-Tuning that best suits the application.

Note: The drive will only show Auto-Tuning parameters that are valid for the control mode that has been set in A1-02. If the control mode is for an induction motor, the Auto-Tuning parameters for PM motors will not be available.

■ Auto-Tuning for Induction Motors

This feature automatically sets the V/f pattern and motor parameters E1-□□ and E2-□□ for an induction motor.

Table i.31 Types of Auto-Tuning for Induction Motors

Type	Setting	Application Conditions and Benefits	Control Mode
			V/f
Stationary Auto-Tuning for Line-to-Line Resistance	T1-01 = 2	<ul style="list-style-type: none"> The drive is used in V/f Control and other Auto-Tuning selections are not possible. Drive and motor capacities differ. Tunes the drive after the cable between the drive and motor has been replaced with a cable over 50 m long. Assumes Auto-Tuning has already been performed. Should not be used for any vector control modes unless the motor cable has changed. 	YES
Rotational Auto-Tuning for V/f Control	T1-01 = 3	<ul style="list-style-type: none"> Recommended for applications using Speed Estimation Speed Search or using the Energy Saving function in V/f Control. Assumes motor can rotate while Auto-Tuning is executed. Increases accuracy for certain functions like torque compensation, slip compensation, Energy Saving, and Speed Search. 	YES

■ T1-01: Auto-Tuning Mode Selection

Sets the type of Auto-Tuning to be used.

No.	Name	Setting Range	Default
T1-01	Auto-Tuning Mode Selection	2, 3 (V/f)	2 (V/f)

Setting 2: Stationary Auto-Tuning for Line-to-Line Resistance

Setting 3: Rotational Auto-Tuning for V/f Control Energy Saving

◆ No-Load Operation Test Run

This section explains how to operate the drive with the motor decoupled from the load during a test run.

■ Before Starting the Motor

Check the following items before operation:

- Ensure the area around the motor is safe.

i.5 Start-Up Programming and Operation

- Ensure external emergency stop circuitry is working properly and other safety precautions have been taken.

■ During Operation

Check the following items during operation:

- The motor should rotate smoothly (i.e., no abnormal noise or oscillation).
- The motor should accelerate and decelerate smoothly.

◆ Test Run with the Load Connected

After performing a no-load test run, connect the motor and proceed to run the motor and load together.

■ Checklist Before Operation

- The motor should rotate in the proper direction.
- The motor should accelerate and decelerate smoothly.

■ Operating the Motor under Loaded Conditions

Test run the application similarly to the no-load test procedure when connecting the machinery to the motor.

- Monitor U1-03 for overcurrent during operation.
- If the application permits running the load in the reverse direction, change the motor direction and the frequency reference while watching for abnormal motor oscillation or vibration.
- Correct any problems that occur with hunting, oscillation, and other control-related issues. Refer to the User Manual for details.

◆ Test Run Checklist

Review the checklist before performing a test run. Check each item that applies.

<input checked="" type="checkbox"/>	No.	Checklist
<input type="checkbox"/>	1	Thoroughly read the manual before performing a test run.
<input type="checkbox"/>	2	Turn the power on.

Check the items that correspond to the control mode being used.

WARNING! *Sudden Movement Hazard. Ensure start/stop and safety circuits are wired properly and in the correct state before energizing the drive. Failure to comply could result in death or serious injury from moving equipment. When programmed for 3-Wire control, a momentary closure on terminal S1 may cause the drive to start.*

<input checked="" type="checkbox"/>	No.	Checklist
V/f Control (A1-02 = 0)		
<input type="checkbox"/>	3	Select the best V/f pattern according to the application and motor characteristics.
<input type="checkbox"/>	4	Perform Rotational Auto-Tuning for V/f Control if using Energy Saving functions.
Open Loop Vector Control for PM (A1-02 = 5)		
<input type="checkbox"/>	5	Perform Auto-Tuning as described.

i.6 Troubleshooting

NOTICE

Refer to the Z1000U HVAC MATRIX Drive User Manual TOEP C710636 10 for information on **Troubleshooting** and complete product instructions necessary for proper installation, set-up, troubleshooting and maintenance.
The Z1000U HVAC MATRIX Drive User Manual is posted on the Yaskawa website, www.yaskawa.com.

◆ Fault Detection

■ Fault Displays

A fault is indicated by a code on the data display and the ALM LED is on. The drive output is always switched off immediately and the motor coast to stop.

To reset a fault, trace and remove the cause, and push the Reset key on the keypad or cycle the power supply.

Refer to the User Manual for a complete list of causes and possible solutions.

HOA Keypad Display	Fault Name
Aov	Power Supply Overvoltage
	The input power supply voltage became equal to or higher than the Input Power Supply Overvoltage Detection Level. 200 V Class: Approximately 277 Vrms 400 V Class: Approximately 630 Vrms
AUv	Power Supply Undervoltage
	The input power supply voltage became equal to or lower than the Input Power Supply Undervoltage Detection Level (L2-21). 200 V Class: Approximately 150 Vrms 400 V Class: Approximately 300 Vrms
bAT	HOA Keypad Battery Low
bUS	Option Communication Error
	<ul style="list-style-type: none"> The connection was lost after establishing initial communication. Only detected when the run command frequency reference is assigned to an option card.
CE	MEMOBUS/Modbus Communication Error
	Control data was not received for the CE detection time set to H5-09.
CoF	Current Offset Fault
	Drive starts operation while the current-detection circuit failure, or the induced voltage remains in the motor (coasting and after rapid deceleration).
CPF00 to CPF03, CPF07, CPF08, CPF11 to CPF14, CPF16 to CPF24, CPF26 to CPF35, CPF40 to CPF45 </> </>	Control Circuit Error
CPF06	Control Circuit Error
	There is an error in the data saved to EEPROM.
CPF25	Terminal Board Not Connected
doH	Damping Resistor Overheat
	The temperature of the built-in damping resistor exceeded the set value.
EF0	Option Card External Fault
	An external fault condition is present.
EF1	External Fault (input terminal S1)
	External fault at multi-function input terminal S1.
EF2	External Fault (input terminal S2)
	External fault at multi-function input terminal S2.
EF3	External Fault (input terminal S3)
	External fault at multi-function input terminal S3.

i.6 Troubleshooting

HOA Keypad Display	Fault Name
EF4	External Fault (input terminal S4)
	External fault at multi-function input terminal S4.
EF5	External Fault (input terminal S5)
	External fault at multi-function input terminal S5.
EF6	External Fault (input terminal S6)
	External fault at multi-function input terminal S6.
EF7	External Fault (input terminal S7)
	External fault at multi-function input terminal S7.
EF8	External Fault (input terminal S8)
	External fault at multi-function input terminal S8.
Err	EEPROM Write Error
	Data cannot be written to the EEPROM
FAn	Fan fault
	Fan failure
FbH	Excessive PID Feedback
	PID feedback input is greater than the level set to b5-36 for longer than the time set to b5-37. Set b5-12 to 2 or 5 to enable fault detection.
FbL	PID Feedback Loss
	PID feedback loss detection is programmed to trigger a fault (b5-12 = 2 or 5) and the PID feedback level is below the detection level set to b5-13 for longer than the time set to b5-14.
Fdv	Power Supply Frequency Fault
	The input power supply frequency exceeded the allowable frequency fluctuation.
GF	Ground Fault
	<ul style="list-style-type: none"> A current short to ground exceeded 50% of rated current on the output side of the drive. Setting L8-09 to 1 enables ground fault detection.
LF	Output Phase Loss
	<ul style="list-style-type: none"> Phase loss on the output side of the drive. Setting L8-07 to 1 or 2 enables Phase Loss Detection.
LF2	Output Current Imbalance
	One or more of the phases in the output current are lost.
nSE	Node Setup Error
	A terminal assigned to the node setup function closed during run.
oC	Overcurrent
	Drive sensors detected an output current greater than the specified overcurrent level.
oFA00	Option Card Connection Error at Option Port CN5-A
	Option compatibility error
oFA01	Option Card Fault at Option Port CN5-A
	Option not properly connected
oFA03 to oFA06 oFA10, oFA11	Option Card Error Occurred at Option Port CN5-A
oFA12 to oFA17	Option Card Connection Error (CN5-A)
oFA30 to oFA43	Communication Option Card Connection Error (CN5-A)
oFb00	Option Card Fault at Option Port CN5-B
	Option compatibility error
oFb01	Option Card Fault at Option Port CN5-B
	Option not properly connected
oFb02	Option Card Fault at Option Port CN5-B
	Same type of option card is currently connected

HOA Keypad Display	Fault Name
oFb03 to oFb11	Option card error occurred at Option Port CN5-B
oFb12 to oFb17	
oFC00	Option Card Connection Error at Option Port CN5-C
	Option compatibility error
oFC01	Option Card Fault at Option Port CN5-C
	Option not properly connected
oFC02	Option Card Fault at Option Port CN5-C
	Same type of option card is currently connected
oFC03 to oFC11	Option Card Error Occurred at Option Port CN5-C
oFC12 to oFC17	
oFC50 to oFC55	Option Card Error Occurred at Option Port CN5-C
oH	Heatsink Overheat
	The heatsink temperature exceeded the overheat pre-alarm level set to L8-02. The default value for L8-02 is determined by drive model selection (o2-04).
oH1	Overheat 1 (Heatsink Overheat)
	The heatsink temperature exceeded the drive overheat level. Overheat level is determined by drive capacity (o2-04).
oH3	Motor Overheat Alarm (PTC Input)
	<ul style="list-style-type: none"> The motor overheat signal to analog input terminal A1, A2, or A3 exceeded the alarm detection level. Detection requires setting multi-function analog inputs H3-02, H3-10, or H3-06 to E.
oH4	Motor Overheat Fault (PTC Input)
	<ul style="list-style-type: none"> The motor overheat signal to analog input terminal A1, A2, or A3 exceeded the fault detection level. Detection requires setting multi-function analog inputs H3-02, H3-10, or H3-06 to E.
oL1	Motor Overload
	The electronic motor overload protection tripped
oL2	Overload
	The thermal sensor of the drive triggered overload protection.
oL3	Overtorque Detection 1
	The current has exceeded the value set for Torque Detection Level 1 (L6-02) for longer than the allowable time (L6-03).
oL4	Overtorque Detection 2
	The current has exceeded the value set for Torque Detection Level 2 (L6-05) for longer than the allowable time (L6-06).
oL5	Mechanical Weakening Detection 1
	Overtorque occurred, matching the conditions specified in L6-08.
oPr	External Digital Operator Connection Fault
	<p>The external operator has been disconnected from the drive.</p> <p>Note: An oPr fault will occur when all of the following conditions are true:</p> <ul style="list-style-type: none"> Output is interrupted when the operator is disconnected (o2-06 = 1). The Run command is assigned to the operator (b1-02 = 0 and LOCAL has been selected).
ov	Control Circuit Overvoltage
	<p>Voltage in the control circuit has exceeded the overvoltage level.</p> <ul style="list-style-type: none"> For 200 V class drives: approximately 450 V For 400 V class drives: approximately 900 V
SCF	Safety Circuit Fault
	Safety Circuit Fault is detected.
SEr	Too Many Speed Search Restarts
	The number of Speed Search restarts exceeded the value set to b3-19.
SoH	Snubber Discharge Resistor Overheat
SrC	Phase Order Detection Fault
	The phase rotation direction for the input power supply changed.
Srr	Internal Resistance Fault
	An operation failure occurred in the snubber discharge resistor circuit.

i.6 Troubleshooting

HOA Keypad Display	Fault Name
STo	Pull-Out Detection
	Motor pull out or step out has occurred. Motor has exceeded its pull-out torque.
SvE	Zero Servo Fault
	Position deviation during zero servo.
TdE	Time Data Error
TIM	Time Not Set
UL3	Undertorque Detection 1
	The current has fallen below the minimum value set for Torque Detection Level 1 (L6-02) for longer than the allowable time (L6-03).
UL5	Mechanical Weakening Detection 2
	The operation conditions matched the conditions set to L6-08.
Uv1	Control Circuit Undervoltage Fault
	Voltage in the control circuit fell below the detection level: <ul style="list-style-type: none"> • For 200 V class drives: approximately 175 V • For 400 V class drives: approximately 350 V
Uv2	Control Power Supply Voltage Fault
	Voltage is too low for the control drive input power.
Uv3	Undervoltage 3 (Soft-Charge Bypass Relay Fault)
	The soft-charge bypass relay failed.

<1> Displayed as CPF00 when occurring at drive power up. When one of the faults occurs after successfully starting the drive, the display will show CPF01.

<2> Displayed as CPF20 when occurring at drive power up. When one of the faults occurs after successfully starting the drive, the display will show CPF21.

◆ Alarm Detection

■ Alarm Codes

An alarm is indicated by a code on the data display and the flashing ALM LED. The drive output is not necessarily switched off.

To remove an alarm, trace and remove the cause, and reset the drive by pushing the Reset key on the keypad or cycle the power supply.

Refer to the User Manual for a complete list of causes and possible solutions.

HOA Keypad Display	Alarm Name
AEr	Station Address Setting Error (CC-Link, CANopen, MECHATROLINK)
	Option card node address is outside of the acceptable setting range.
AUv	Power Supply Undervoltage
	The input power supply voltage became equal to or lower than the Input Power Supply Undervoltage Detection Level (L2-21). 200 V Class: Approximately 150 Vrms 400 V Class: Approximately 300 Vrms
bb	Baseblock
	Drive output interrupted as indicated by an external baseblock signal.
bUS	Option Communication Error
	<ul style="list-style-type: none"> • The connection was lost after establishing initial communication. • Only detected when the run command frequency reference is assigned to an option card.
CALL	Serial Communication Transmission Error
	Communication has not yet been established.
CE	MEMOBUS/Modbus Communication Error
	Control data was not received for the CE detection time set to H5-09.
CrST	Cannot Reset
dnE	Drive Disabled

HOA Keypad Display	Alarm Name
doH	Damping Resistor Overheat
	The temperature of the built-in damping resistor exceeded the set value.
EF	Forward/Reverse Run Command Input Error
	Both forward run and reverse run closed simultaneously for longer than 0.5 s.
EF0	Option Card External Fault
	An external fault condition is present.
EF1	External Fault (input terminal S1)
	External fault at multi-function input terminal S1.
EF2	External Fault (input terminal S2)
	External fault at multi-function input terminal S2.
EF3	External Fault (input terminal S3)
	External fault at multi-function input terminal S3.
EF4	External Fault (input terminal S4)
	External fault at multi-function input terminal S4.
EF5	External Fault (input terminal S5)
	External fault at multi-function input terminal S5.
EF6	External Fault (input terminal S6)
	External fault at multi-function input terminal S6.
EF7	External Fault (input terminal S7)
	External fault at multi-function input terminal S7.
EF8	External Fault (input terminal S8)
	External fault at multi-function input terminal S8.
FbH	Excessive PID Feedback
	PID feedback input is greater than the level set to b5-36 for longer than the time set to b5-37. Set b5-12 to 2 or 5 to enable fault detection.
FbL	PID Feedback Loss
	PID feedback loss detection is programmed to trigger a fault (b5-12 = 2 or 5) and the PID feedback level is below the detection level set to b5-13 for longer than the time set to b5-14.
Fdv	Power Supply Frequency Fault
	The input power supply frequency exceeded the allowable frequency fluctuation.
HCA	Current Alarm
	Drive current exceeded overcurrent warning level (150% of the rated current).
LT-1	Cooling Fan Maintenance Time
	The cooling fan has reached its expected maintenance period and may need to be replaced. Note: An alarm output (H2-□□ = 10) will only be triggered if both (H2-□□ = 2F and H2-□□ = 10) are set.
LT-2	Capacitor Maintenance Time
	The main circuit and control circuit capacitors are nearing the end of their expected performance life. Note: An alarm output (H2-□□ = 10) will only be triggered if H2-□□ = 2F.
LT-3	Soft Charge Bypass Relay Maintenance Time
	The DC bus soft charge relay is nearing the end of its expected performance life. Note: An alarm output (H2-□□ = 10) will only be triggered if H2-□□ = 2F.
oH	Heatsink Overheat
	The heatsink temperature exceeded the overheat pre-alarm level set to L8-02. The default value for L8-02 is determined by drive model selection (o2-04).
oH2	Heatsink Overheat Warning
	“Heatsink Overheat Warning” was input to a multi-function input terminal, S1 through S8 (H1-□□ = B).
oH3	Motor Overheat Alarm (PTC Input)
	<ul style="list-style-type: none"> The motor overheat signal to analog input terminal A1, A2, or A3 exceeded the alarm detection level. Detection requires setting multi-function analog inputs H3-02, H3-10, or H3-06 to E.

i.6 Troubleshooting

HOA Keypad Display	Alarm Name
oL3	Overtorque Detection 1
	The current has exceeded the value set for Torque Detection Level 1 (L6-02) for longer than the allowable time (L6-03).
ov	Control Circuit Overvoltage
	Voltage in the control circuit exceeded the trip point. <ul style="list-style-type: none"> For 200 V class drives: approximately 450 V For 400 V class drives: approximately 900 V
PASS	MEMOBUS/Modbus Comm. Test Mode Complete
SE	MEMOBUS/Modbus Communication Test Mode Error Note: This alarm will not trigger a multi-function output terminal that is set for alarm output (H2-□□ = 10).
SrC	Phase Order Detection Fault
	The phase rotation direction for the input power supply changed.
UL3	Undertorque Detection 1
	The current has fallen below the minimum value set for Torque Detection Level 1 (L6-02) for longer than the allowable time (L6-03).
Uv	Control Circuit Undervoltage
	One of the following conditions occurred: <ul style="list-style-type: none"> Contactor to suppress inrush current in the drive was opened. Low voltage in the control drive input power. This alarm outputs only if L2-01 is not 0 and DC bus voltage is under L2-05.
WrUn	Waiting for Run
	A Run command has been issued and the drive is waiting to begin running the motor.

◆ Operator Programming Errors

■ oPE Codes

An Operator Programming Error (oPE) occurs when a contradictory parameter is set or an individual parameter is set to an inappropriate value.

The drive will not operate until the parameter or parameters causing the problem are set correctly. An oPE, however, does not trigger an alarm or fault output. When an oPE appears on the keypad display, press the ENTER button to view U1-18 and see which parameter is causing the oPE.

HOA Keypad Display	Error Name
oPE01	Unit Capacity Setting Fault
	Unit capacity and the value set to o2-04 do not match.
oPE02	Parameter Range Setting Error
	Use U1-18 to find parameters set outside the range.
oPE03	Multi-Function Input Selection Error
	A contradictory setting is assigned to multi-function contact inputs H1-01 to H1-08.
oPE05	Run Command/Frequency Reference Source Selection Error
oPE07	Multi-Function Analog Input Selection Error
	A contradictory setting is assigned to multi-function analog inputs H3-02, H3-10, or H3-06 and PID functions conflict.
oPE08	Parameter Selection Error
	A function has been set that cannot be used in the motor control method selected.
oPE09	PID Control Selection Fault
	PID control function selection is incorrect. Requires that PID control is enabled (b5-01 = 1 to 4).
oPE10	V/f Data Setting Error
	One or more of the parameters listed below are not set according to the formula:
	<ul style="list-style-type: none"> $E1-09 \leq E1-07 < E1-06 \leq E1-11 \leq E1-04$ $E3-09 \leq E3-07 < E3-06 \leq E3-11 \leq E3-04$
oPE11	Carrier Frequency Setting Error
	Correct the setting for the carrier frequency.
oPE16	Energy Savings Constants Error

HOA Keypad Display	Error Name
oPE27	BP Program Error
	Bypass mode is not correctly configured.
oPE28	Sequence Timer Error
	One or more of the sequence timers is not set in the correct order.
oPE30	Incorrect Input Voltage Adjustment
	The input voltage offset adjustment has not been performed.

◆ Auto-Tuning Errors

■ Auto-Tuning Codes

Auto-Tuning faults in this section are displayed on the HOA keypad and will cause the motor to coast to a stop. Auto-Tuning faults do not trigger a multi-function digital output set for fault or alarm output.

An End□ error on the HOA keypad display indicates Auto-Tuning has successfully completed with discrepancies in the calculations. Restart Auto-Tuning after fixing the cause of the End□ error.



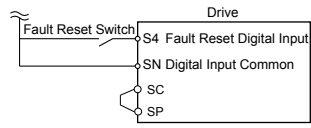
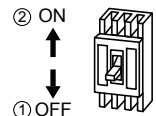
The drive may be used in the application if no cause can be identified despite the existence of an End□ error.

An Er□ error indicates that Auto-Tuning has not completed successfully. Check for the cause of the error using the tables in this section, and perform Auto-Tuning again after fixing the cause.

HOA Keypad Display	Error Name
End3	Rated Current Setting Alarm (displayed after Auto-Tuning is complete)
End4	Adjusted Slip Calculation Error
End5	Resistance Tuning Error
End7	No-Load Current Alarm
Er-01	Motor Data Error
Er-02	Minor Fault
Er-03	STOP Button Input
Er-04	Line-to-Line Resistance Error
Er-05	No-Load Current Error
Er-08	Rated Slip Error
Er-09	Acceleration Error
Er-12	Current Detection Error

◆ Fault Reset Methods

When a fault occurs, the cause of the fault must be removed and the drive must be restarted. The table below lists the different ways to restart the drive.

After the Fault Occurs	Procedure	
Fix the cause of the fault, restart the drive, and reset the fault.	Press  on the HOA keypad when the error code is displayed.	
Resetting via Fault Reset Digital Input S4	Close then open the fault signal digital input via terminal S4. S4 is set for "Fault Reset" as default (H1-04 = 14).	
Turn off the main power supply if the above methods do not reset the fault. Reapply power after the HOA keypad display has turned off. When an "SC" error occurs, contact Yaskawa or a Yaskawa agent before cycling the power to the drive.		

Note: If the Run command is present, the drive will disregard any attempts to reset the fault. Remove the Run command before attempting to clear a fault situation.

i.7 Drive Specifications

- Note:**
1. Perform rotational Auto-Tuning to obtain the performance specifications given below.
 2. For optimum performance life of the drive, install the drive in an environment that meets the required specifications.

Item		Specification
Control Characteristics	Control Method	The following control methods can be set using drive parameters: <ul style="list-style-type: none"> • V/f Control (V/f) • Open Loop Vector Control for PM (OLV/PM)
	Frequency Control Range	0.01 to 400 Hz
	Frequency Accuracy (Temperature Fluctuation)	Digital input: within $\pm 0.01\%$ of the max output frequency (-10 to +40 °C) (14 °F to 104 °F) Analog input: within $\pm 0.1\%$ of the max output frequency (25 °C ± 10 °C) (77 °F ± 50 °F)
	Frequency Setting Resolution	Digital inputs: 0.01 Hz Analog inputs: 1/2048 of the maximum output frequency setting (11 bit plus sign)
	Output Frequency Resolution	0.001 Hz
	Frequency Setting Signal	Main speed frequency reference: DC -10 to +10 V (20 k Ω), DC 0 to +10 V (20 k Ω), 4 to 20 mA (250 Ω), 0 to 20 mA (250 Ω)
	Starting Torque	V/f: 150% at 3 Hz OLV/PM: 100% at 3 Hz $\langle \rangle$
	Speed Control Range	V/f: 1:40 OLV/PM: 1:20
	Speed Control Accuracy	V/f: ± 0.2 to 3% (25 °C ± 10 °C) (77 °F ± 50 °F) OLV/PM: $\pm 0.2\%$ (25 °C ± 10 °C) (77 °F ± 50 °F) $\langle \rangle$
	Speed Response	OLV/PM: 10 Hz (25 °C ± 10 °C) (77 °F ± 50 °F)
	Accel/Decel Time	0.0 to 6000.0 s (4 selectable combinations of independent acceleration and deceleration settings)
	Braking Torque	Same value as overload tolerance in motoring or regeneration.
	V/f Characteristics	User-selected programs and V/f preset patterns possible
Main Control Functions	Momentary Power Loss Ride-Thru, Speed Search, Overtorque/Undertorque Detection, 4 Step Speed (max), Accel/Decel Switch, S-curve Accel/decel, 3-Wire Sequence, Auto-Tuning (Stationary for Line-to-Line Resistance, Rotational for V/f Control), Cooling Fan on/off Switch, Slip Compensation, Torque Compensation, Frequency Jump, Upper/lower Limits for Frequency Reference, DC Injection Braking at Start and Stop, Overexcitation Braking, PID Control (with sleep function), Energy Saving Control, APOGEE FLN Comm. (RS-422/RS-485 4.8 kbps), BACnet Comm. (RS-485 max. 76.8 kbps), MEMOBUS/Modbus Comm. (RS-422/RS-485 max, 115.2 kbps), Metasys N2 Comm. (RS-422/RS-485 9.6 kbps), Fault Restart, Application Presets, Overexcitation Deceleration, Sequence Timer Operation, Secondary PI Control, Bypass Operation, HOA Keypad, Dynamic Noise Control	
Protection Functions	Power Supply Regeneration	Available
	Motor Protection	Electronic thermal overload relay
	Momentary Overcurrent Protection	Drive stops when output current reaches about 200% of the rated current
	Overload Protection	Drive stops after 60 s at 150% of rated output current $\langle \rangle$
	Overvoltage Protection	200 V class: Stops when input voltage exceeds approx. 315 V 400 V class: Stops when input voltage exceeds approx. 630 V
	Undervoltage Protection	200 V class: Stops when input voltage falls below approx. 150 V 400 V class: Stops when input voltage falls below approx. 300 V
	Momentary Motor Power Ride-Thru During Utility Power Loss	2 ms or longer at full load $\langle \rangle$
	Momentary Control Power Ride-Thru During Utility Power Loss	Typically 2 seconds or longer $\langle \rangle$
	Stall Prevention	Stall Prevention is available during acceleration, deceleration, and during run.
	Ground Protection	Electronic circuit protection $\langle \rangle$
Charge LED of Capacitor for Control Power Supply	Remains lit until control power supply voltage falls below 50 V	

Item		Specification
Environment	Area of Use	Indoors
	Ambient Temperature	IP20/UL Type 1 enclosure: -10 °C to +40 °C (14 °F to 104 °F) IP00 enclosure: -10 °C to +50 °C (14 °F to 122 °F)
	Humidity	95 RH% or less (no condensation)
	Storage Temperature	-20 °C to +60 °C (-4 °F to +104 °F) (short-term temperature during transportation)
	Altitude	Up to 1000 meters without derating, up to 3000 m with output current and voltage derating.
	Vibration/Shock	10 to 20 Hz: 9.8 m/s ² (2□0028 to 2□0248 and 4□0011 to 4□0414) 20 to 55 Hz: 5.9 m/s ² (2□0028 to 2□0081 and 4□0011 to 4□0077) 20 to 55 Hz: 2.0 m/s ² (2□0104 to 2□0248 and 4□0096 to 4□0414)
Standards		<ul style="list-style-type: none"> • UL 61800-5-1 • IEC/EN 61800-3, IEC/EN 61800-5-1:2007
Protection Design		IP00/Open Type enclosure <7>, IP20/UL Type 1 enclosure

- <1> Current derating is required. Select control modes in accordance with drive capacity.
- <2> The accuracy of these values depends on motor characteristics, ambient conditions, and drive settings. Specifications may vary with different motors and with changing motor temperature. Contact Yaskawa for consultation.
- <3> Overload protection may be triggered when operating with 150% of the rated output current if the output frequency is less than 6 Hz.
- <4> Momentary motor power ride-thru during utility power loss designates the time the drive is able to maintain control over a motor operating at full load after utility power is lost. Actual specifications may vary depending on motor characteristics.
- <5> An auxiliary 24 VDC Control Power Supply option is required if the application needs to maintain control power long after a 2 second momentary power loss.
- <6> Ground protection is triggered when a ground short circuit occurs while the drive is running. The ground protection cannot be provided when the impedance of the ground fault path is too low, or when the drive is powered up while a ground fault is present at the output.
- <7> An IP20/UL Type 1 enclosure drive requires a UL Type 1 kit.

i.8 Parameter Table

This parameter table shows the most important parameters. Default settings are in **bold type**. Refer to the Programming Manual for a complete list of parameters.

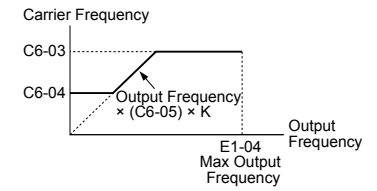
No.	Name	Description
A1-00	Language Selection	0: English 1: Japanese 3: French 5: Spanish 6: Portuguese
A1-01	Access Level Selection	Selects which parameters are accessible via the HOA keypad. 0: Operation only. A1-01, A1-04, and A1-06 can be set and monitored, and U□-□□ parameters can also be viewed. 1: User Parameters. Only parameters A1-00, A1-01, and A1-04, and A2-01 to A2-32 in Setup Mode can be set and monitored. 2: Advanced Access Level. All parameters can be set and monitored.
A1-02	Control Method Selection	0: V/f Control 5: Open Loop Vector Control for PM
A1-03	Initialize Parameters	0: No initialization 1110: User Initialize (parameter values must be stored using parameter o2-03) 2220: 2-Wire Initialization 3330: 3-Wire Initialization 3410: HVAC Initialization 3420: OEM Bypass Initialization
A1-04	Password	When the value set into A1-04 does not match the value set into A1-05, parameters A1-01 through A1-03, A1-06, and A2-01 through A2-32 cannot be changed.
A1-05	Password Setting	
A1-06	Application Preset	0: Standard 1: Fan 2: Fan with PID Control 3: Return Fan with PID Control 4: Cooling Tower Fan 5: Cooling Tower Fan with PID Control 6: Pump (Secondary) 7: Pump with PID Control
A2-01 to A2-32	User Parameters 1 to 32	Parameters selected by the user are saved as User Parameters, including changed parameters and parameters specifically selected for quick access. If parameter A2-33 is set to 1, changed parameters will be listed between A2-17 and A2-32. Parameters A2-01 through A2-16 must be manually selected by the user. If A2-33 is set to 0, recently viewed parameters will not be saved to the group of User Parameters. A2-□□ parameters are now available for manual programming.
b1-01	Frequency Reference Selection for AUTO Mode	0: HOA keypad 1: Terminals (Analog Input Terminals) 2: Serial communications (APOGEE FLN, BACnet, MEMOBUS/Modbus, or Metasys N2) 3: Option card
b1-02	Run Command Selection for AUTO Mode	1: Control Circuit Terminal 2: Serial communications (APOGEE FLN, BACnet, MEMOBUS/Modbus, or Metasys N2) 3: Option card
b1-03	Stopping Method Selection	0: Ramp to stop 1: Coast to stop 2: DC Injection Braking to stop 3: Coast with timer
b1-04	Reverse Operation Selection	0: Reverse enabled 1: Reverse disabled

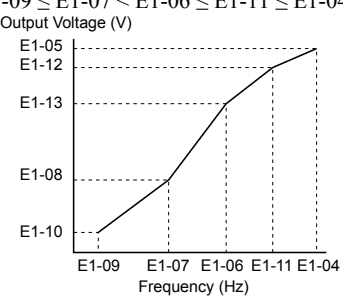
No.	Name	Description
b1-14	Phase Order Selection	0: Standard 1: Switch phase order (reverses the direction of the motor)
b1-17	Run Command at Power Up	0: Disregarded A new Run command must be issued after power up. 1: Allowed Motor will start immediately after power up if a Run command is already enabled.
b2-01	DC Injection Braking Start Frequency	Sets the frequency at which DC Injection Braking starts when “Ramp to stop” (b1-03 = 0) is selected.
b2-02	DC Injection Braking Current	Sets the DC Injection Braking current as a percentage of the drive rated current.
b2-03	DC Injection Braking Time at Start	Sets DC Injection Braking time at start. Disabled when set to 0.00 seconds.
b2-04	DC Injection Braking Time at Stop	Sets DC Injection Braking time at stop.
b2-09	Motor Pre-Heat Current 2	Determines the percentage of motor rated output current used for the motor pre-heat function.
b3-01	Speed Search Selection at Start	0: Disabled 1: Enabled Note: Default setting is dependent upon parameter A1-02, Control Method Selection.
b3-02	Speed Search Deactivation Current	Sets the current level at which the speed is assumed to be detected and Speed Search is ended. Set as a percentage of the drive rated current.
b3-03	Speed Search Deceleration Time	Sets output frequency reduction time during Speed Search.
b3-04	V/f Gain during Speed Search (Speed Estimation Type)	Determines how much to lower the V/f ratio during Speed Search. Output voltage during Speed Search equals the V/f setting multiplied by b3-04.
b3-05	Speed Search Delay Time	When using an external contactor on the output side, b3-05 delays executing Speed Search after a momentary power loss to allow time for the contactor to close.
b3-06	Output Current 1 during Speed Search (Speed Estimation Type)	Sets the current injected to the motor at the beginning of Speed Estimation Speed Search. Set as a coefficient for the motor rated current.
b3-10	Speed Search Detection Compensation Gain (Speed Estimation Type)	Sets the gain which is applied to the speed detected by Speed Estimation Speed Search before the motor is reaccelerated. Increase this setting if ov occurs when performing Speed Search after a relatively long period of baseblock.
b3-14	Bi-Directional Speed Search Selection (Speed Estimation Type)	0: Disabled (uses the direction of the frequency reference) 1: Enabled (drive detects which way the motor is rotating) Note: Default setting is dependent upon parameter A1-02, Control Method Selection.
b3-17	Speed Search Restart Current Level (Speed Estimation Type)	Sets the Speed Search restart current level as a percentage of the drive rated current.
b3-18	Speed Search Restart Detection Time (Speed Estimation Type)	Sets the time to detect Speed Search restart.

No.	Name	Description	No.	Name	Description
b3-19	Number of Speed Search Restarts (Speed Estimation Type)	Sets the number of times the drive can attempt to restart when performing Speed Search.	b5-17	PID Accel/Decel Time	Sets the acceleration and deceleration time to PID setpoint.
b3-24	Speed Search Method Selection	1: Speed Estimation 2: Current Detection 2 Note: Default setting is dependent upon parameters A1-02, Control Method Selection, and o2-04, Drive Model Selection.	b5-18	PID Setpoint Selection	0: Disabled 1: Enabled
b3-25	Speed Search Wait Time	Sets the time the drive must wait between each Speed Search restart attempt.	b5-19	PID Setpoint Value	Sets the PID target value when b5-18 = 1. Set as a percentage of the maximum output frequency.
b3-27	Start Speed Search Select	0: Triggered when a Run command is issued. (normal). 1: Triggered when an external baseblock is released.	b5-20	PID Setpoint Scaling	0: 0.01 Hz units 1: 0.01% units (100% = max output frequency) 2: r/min (number of motor poles must entered) 3: User-set (set scaling to b5-38 and b5-39)
b5-01	PID Function Setting	0: Disabled 1: Enabled (PID output becomes output frequency reference) 3: Enabled (PID output added to frequency reference)	b5-21	PID Sleep Input Source	Input source selection for Sleep Function mode. 0: PID Setpoint 1: SFS Input 2: Snooze
b5-02	Proportional Gain Setting (P)	Sets the proportional gain of the PID controller.	b5-22	PID Snooze Level	Sets the PID Snooze Function start level as a percentage of the maximum frequency.
b5-03	Integral Time Setting (I)	Sets the integral time for the PID controller.	b5-23	PID Snooze Delay Time	Sets the PID Snooze Function delay time in seconds.
b5-04	Integral Limit Setting	Sets the maximum output possible from the integrator as a percentage of the maximum output frequency.	b5-24	PID Snooze Deactivation Level	When the PID feedback level drops below this level, the drive returns to normal operation. Set as a percentage of the maximum frequency.
b5-05	Derivative Time (D)	Sets D control derivative time.	b5-25	PID Setpoint Boost Setting	Temporarily increases the PID setpoint to create an overshoot of the intended PID setpoint.
b5-06	PID Output Limit	Sets the maximum output possible from the entire PID controller as a percentage of the maximum output frequency.	b5-26	PID Maximum Boost Time	Sets the maximum boost time when PID feedback does not reach boost level. The Snooze Function starts when the PID feedback exceeds the boost setting level or when the boost time expires.
b5-07	PID Offset Adjustment	Applies an offset to the PID controller output. Set as a percentage of the maximum output frequency.	b5-27	PID Snooze Feedback Level	Sets the PID feedback level above which Snooze mode is activated. Set as a percentage of the maximum frequency.
b5-08	PID Primary Delay Time Constant	Sets a low pass filter time constant on the output of the PID controller.	b5-28	PID Feedback Function Selection	0: Disabled 1: Square root
b5-09	PID Output Level Selection	0: Normal output (direct acting) 1: Reverse output (reverse acting)	b5-29	PID Square Root Gain	A multiplier applied to the square root of the feedback.
b5-10	PID Output Gain Setting	Sets the gain applied to the PID output.	b5-30	PID Feedback Offset	PID feedback offset set as a percentage of the maximum frequency.
b5-11	PID Output Reverse Selection	0: Negative PID output triggers zero limit. 1: Rotation direction reverses with negative PID output. Note: When using setting 1, make sure reverse operation is permitted by b1-04.	b5-34	PID Output Lower Limit	Sets the minimum output possible from the PID controller as a percentage of the maximum output frequency.
b5-12	PID Feedback Loss Detection Selection	0: Digital Output Only (Remains active when PID is disabled by digital input) 1: Alarm output, drive continues operation (Remains active when PID is disabled by digital input) 2: Fault output, drive output is shut off (Remains active when PID is disabled by digital input) 3: Digital output only. No detection when PID is disabled by digital input. 4: Alarm detection. No detection when PID is disabled by digital input. 5: Fault detection. No detection when PID is disabled by digital input.	b5-35	PID Input Limit	Limits the PID control input (deviation signal) as a percentage of the maximum output frequency. Acts as a bipolar limit.
b5-13	PID Feedback Loss Detection Level	Sets the PID feedback loss detection level as a percentage of the maximum output frequency.	b5-36	PID Feedback High Detection Level	Sets the PID feedback high detection level as a percentage of the maximum output frequency.
b5-14	PID Feedback Loss Detection Time	Sets a delay time for PID feedback loss.	b5-37	PID Feedback High Detection Time	Sets the PID feedback high level detection delay time.
b5-15	PID Sleep Function Start Level	Sets the frequency level that triggers the sleep/snooze function.	b5-38	PID Setpoint User Display	Sets the display value of U5-01 and U5-04 when the maximum frequency is output.
b5-16	PID Sleep Delay Time	Sets a delay time before the sleep/snooze function is triggered.	b5-39	PID Setpoint Display Digits	0: No decimal places 1: One decimal place 2: Two decimal places 3: Three decimal places Note: Default setting is dependent upon parameter b5-20, PID Setpoint Scaling.
			b5-40	Frequency Reference Monitor Content during PID	0: Display the frequency reference (U1-01) after PID compensation has been added. 1: Display the frequency reference (U1-01) before PID compensation has been added.

i.8 Parameter Table

No.	Name	Description
b5-41	PID Unit Selection	0: WC (Inch of water) 1: PSI (Pounds per square inch) 2: GPM (Gallons per minute) 3: F (Degrees Fahrenheit) 4: CFM (Cubic feet per minute) 5: CMH (Cubic meters per hour) 6: LPH (Liters per hour) 7: LPS (Liters per second) 8: Bar (Bar) 9: Pa (Pascal) 10: C (Degrees Celsius) 11: Mtr (Meters) 12: Ft (Feet) 13: LPM (Liters per minute) 14: CMM (Cubic meters per minute)
b5-42	PID Output Monitor Calculation Method	0: Linear - the monitor displays PID output 1: Square root - the monitor displays square root PID output 2: Quadratic - the monitor displays 1/(PID output) 3: Cubic - the monitor displays 1/(PID output)
b5-43	Custom PID Output Monitor Setting 1	Set maximum monitor value at maximum frequency. U5-07 and U5-08 show Custom PID output. U5-43 shows the upper four digits and U5-44 shows the lower four digits. It shows 999999.99 maximum.
b5-44	Custom PID Output Monitor Setting 2	Sets the minimum display value at zero speed. b5-07 and b5-08 show Custom PID output.
b5-45	Custom PID Output Monitor Setting 3	This function is effective when b5-42 is set to 1 (Linear unit)
b5-46	PID Setpoint Monitor Unit Selection	0: WC (Inch of water) 1: PSI (Pounds per square inch) 2: GPM (Gallons per minute) 3: F (Degrees Fahrenheit) 4: CFM (Cubic feet per minute) 5: CMH (Cubic meters per hour) 6: LPH (Liters per hour) 7: LPS (Liters per second) 8: Bar (Bar) 9: Pa (Pascal) 10: C (Degrees Celsius) 11: Mtr (Meters) 12: Ft (Feet) 13: LPM (Liters per minute) 14: CMM (Cubic meters per minute)
b5-47	Reverse Operation Selection 2 by PID Output	Reverse operation selection when b5-01 = 3 0: Reverse Disabled 1: Reverse Enabled
b8-01	Energy Saving Control Selection	0: Disabled 1: Enabled Note: Default setting is dependent upon parameter A1-02, Control Method Selection.
C1-01	Acceleration Time 1	Sets the time to accelerate from 0 to maximum frequency.
C1-02	Deceleration Time 1	Sets the time to decelerate from maximum frequency to 0.
C1-03	Acceleration Time 2	Sets the time to accelerate from 0 to maximum frequency.
C1-04	Deceleration Time 2	Sets the time to decelerate from maximum frequency to 0.
C1-11	Accel/Decel Time Switching Frequency	Sets the frequency to switch between accel/ decel time settings
C2-01	S-Curve Characteristic at Accel Start	S-curve at acceleration start.
C2-02	S-Curve Characteristic at Accel End	S-curve at acceleration end.

No.	Name	Description
C6-02	Carrier Frequency Selection	1: 4.0 kHz 2: 6.0 kHz 3: 8.0 kHz 4: 10.0 kHz F: User-defined (determined by C6-03 through C6-05) Note: Default setting is dependent upon parameters A1-02, Control Method Selection, and o2-04, Drive Model Selection.
C6-03	Carrier Frequency Upper Limit	Determines the upper and lower limits for the carrier frequency. 
C6-04	Carrier Frequency Lower Limit	
C6-05	Carrier Frequency Proportional Gain	
C7-60	Output Voltage Limit Mode Selection	0: Harmonic suppression priority mode 1: High output voltage mode
d1-01 to d1-16	Frequency Reference 1 to 4; 16	Sets the frequency reference for the drive. Setting units are determined by parameter o1-03.
d1-17	Jog Frequency Reference	Sets the Jog frequency reference. Setting units are determined by parameter o1-03.
d2-01	Frequency Reference Upper Limit	Sets the frequency reference upper limit as a percentage of the maximum output frequency.
d2-02	Frequency Reference Lower Limit	Sets the frequency reference lower limit as a percentage of the maximum output frequency.
d2-03	Master Speed Reference Lower Limit	Sets the lower limit for frequency references from analog inputs as a percentage of the maximum output frequency.
d3-01	Jump Frequency 1	The drive accelerates and decelerates the motor through the prohibited frequency ranges. Parameters must be set so that d3-01 ≥ d3-02 ≥ d3-03.
d3-02	Jump Frequency 2	
d3-03	Jump Frequency 3	
d3-04	Jump Frequency Width	Sets the dead-band width around each selected prohibited frequency reference point.
E1-03	V/f Pattern Selection	0: 50 Hz, Constant torque 1 1: 60 Hz, Constant torque 2 2: 60 Hz, Constant torque 3 (50 Hz base) 3: 72 Hz, Constant torque 4 (60 Hz base) 4: 50 Hz, Variable torque 1 5: 50 Hz, Variable torque 2 6: 60 Hz, Variable torque 3 7: 60 Hz, Variable torque 4 8: 50 Hz, High starting torque 1 9: 50 Hz, High starting torque 2 A: 60 Hz, High starting torque 3 B: 60 Hz, High starting torque 4 C: 90 Hz (60 Hz base) D: 120 Hz (60 Hz base) E: 180 Hz (60 Hz base) F: Custom V/f E1-04 through E1-13 settings define the V/f pattern

No.	Name	Description	No.	Name	Description
E1-04	Maximum Output Frequency	<p>These parameters are only applicable when E1-03 is set to F.</p> <p>To set linear V/f characteristics, set the same values for E1-07 and E1-09. In this case, the setting for E1-08 will be disregarded. Ensure that the four frequencies are set according to these rules: $E1-09 \leq E1-07 < E1-06 \leq E1-11 \leq E1-04$</p>  <p>Output Voltage (V)</p> <p>Frequency (Hz)</p>	H2-08	MEMOBUS Register 1 Bit Select	Sets the bits for the MEMOBUS/Modbus registers from which data will be sent to contact outputs 62 and 162.
E1-05	Maximum Voltage		H2-09	MEMOBUS Register 2 Address Select	Sets the addresses of the MEMOBUS/Modbus registers from which data will be sent to contact outputs 63 and 163.
E1-06	Base Frequency		H2-10	MEMOBUS Register 2 Bit Select	Sets the bits for the MEMOBUS/Modbus registers from which data will be sent to contact outputs 63 and 163.
E1-07	Middle Output Frequency		H3-01	Terminal A1 Signal Level Selection	<p>0: 0 to 10 V with zero limit</p> <p>1: 0 to 10 V without zero limit</p> <p>2: 4-20 mA</p> <p>3: 0-20 mA</p> <p>Note: Use Jumper S1 to set input terminal A1 for a current or voltage input signal.</p>
E1-08	Middle Output Frequency Voltage		H3-02	Terminal A1 Function Selection	Sets the function of terminal A1.
E1-09	Minimum Output Frequency		H3-03	Terminal A1 Gain Setting	Sets the level of the input value selected in H3-02 when 10 V is input at terminal A1.
E1-10	Minimum Output Frequency Voltage		H3-04	Terminal A1 Bias Setting	Sets the level of the input value selected in H3-02 when 0 V is input at terminal A1.
E1-11	Middle Output Frequency 2		H3-05	Terminal A3 Signal Level Selection	<p>0: 0 to 10 Vdc (20 kΩ)</p> <p>1: 4 to 20 mA (250 Ω)</p> <p>2: 0 to 20 mA (250 Ω)</p>
E1-12	Middle Output Frequency Voltage 2		H3-06	Terminal A3 Function Selection	Sets the function of terminal A3.
E1-13	Base Voltage		H3-07	Terminal A3 Gain Setting	Sets the level of the input value selected in H3-06 when 10 V is input at terminal A3.
E2-01	Motor Rated Current		H3-08	Terminal A3 Bias Setting	Sets the level of the input value selected in H3-06 when 0 V is input at terminal A3.
E2-11	Motor Rated Power		H3-09	Terminal A2 Signal Level Selection	<p>0: 0 to 10 V with zero limit</p> <p>1: 0 to 10 V without zero limit</p> <p>2: 4 to 20 mA</p> <p>3: 0 to 20 mA</p> <p>Note: Use Jumper S1 to set input terminal A2 for a current or voltage input signal.</p>
E5-01	Motor Code Selection (for PM Motors)		H3-10	Terminal A2 Function Selection	Sets the function of terminal A2.
E5-02	Motor Rated Power	H3-11	Terminal A2 Gain Setting	Sets the level of the input value selected in H3-10 when 10 V (20 mA) is input at terminal A2.	
E5-03	Motor Rated Current	H3-12	Terminal A2 Bias Setting	Sets the level of the input value selected in H3-10 when 0 V (0 or 4 mA) is input at terminal A2.	
E5-04	Number of Motor Poles	H3-13	Analog Input Filter Time Constant	Sets a primary delay filter time constant for terminals A1, A2, and A3. Used for noise filtering.	
E5-05	Motor Stator Resistance	H3-14	Analog Input Terminal Enable Selection	<p>1: Terminal A1 only</p> <p>2: Terminal A2 only</p> <p>3: Terminals A1 and A2 only</p> <p>4: Terminal A3 only</p> <p>5: Terminals A1 and A3</p> <p>6: Terminals A2 and A3</p> <p>7: All terminals enabled</p>	
E5-06	Motor d-Axis Inductance	H3-16	Terminal A1 Offset	Adds an offset when the analog signal to terminal A1 is at 0 V.	
E5-07	Motor q-Axis Inductance	H3-17	Terminal A2 Offset	Adds an offset when the analog signal to terminal A2 is at 0 V.	
E5-09	Motor Induction Voltage Constant 1	H3-18	Terminal A3 Offset	Adds an offset when the analog signal to terminal A3 is at 0 V.	
E5-24	Motor Induction Voltage Constant 2	H4-01	Multi-Function Analog Output Terminal FM Monitor Selection	Selects the data to be output through multi-function analog output terminal FM. Set the desired monitor parameter to the digits available in U□-□□. For example, enter "103" for U1-03.	
F6-01	Communications Error Operation Selection	H4-02	Multi-Function Analog Output Terminal FM Gain	Sets the signal level at terminal FM that is equal to 100% of the selected monitor value.	
H1-01 to H1-08	Multi-Function Digital Input Terminal S1 to S8 Function Selection			Selects the function of terminals S1 to S8.	
H2-01 to H2-03	Multi-Function Digital Output Terminal Function Selection			Selects the function of terminals M1-M2, M3-M4, and MD-ME-MF.	
H2-06	Power Consumption Output Unit Selection			<p>0: 0.1 kWh units</p> <p>1: 1 kWh units</p> <p>2: 10 kWh units</p> <p>3: 100 kWh units</p> <p>4: 1000 kWh units</p> <p>Note: The setting range is 1 to 4 in drive software versions PRG: 6113 and earlier.</p>	
H2-07	MEMOBUS Register 1 Address Select			Sets the addresses of the MEMOBUS/Modbus registers from which data will be sent to contact outputs 62 and 162.	

i.8 Parameter Table

No.	Name	Description
H4-03	Multi-Function Analog Output Terminal FM Bias	Sets the signal level at terminal FM that is equal to 0% of the selected monitor value.
H4-04	Multi-Function Analog Output Terminal AM Monitor Selection	Selects the data to be output through multi-function analog output terminal AM. Set the desired monitor parameter to the digits available in U□-□□. For example, enter "103" for U1-03.
H4-05	Multi-Function Analog Output Terminal AM Gain	Sets the signal level at terminal AM that is equal to 100% of the selected monitor value.
H4-06	Multi-Function Analog Output Terminal AM Bias	Sets the signal level at terminal AM that is equal to 0% of the selected monitor value.
H4-07	Multi-Function Analog Output Terminal FM Signal Level Selection	0: 0 to 10 V 1: -10 to 10 V 2: 4 to 20mA
H4-08	Multi-Function Analog Output Terminal AM Signal Level Selection	0: 0 to 10 V 1: -10 to 10 V 2: 4 to 20 mA
H5-01	Drive Node Address	Selects drive station slave number (address) for MEMOBUS/Modbus terminals R+, R-, S+, S-. Note: Cycle power for the setting to take effect.
H5-02	Communication Speed Selection	0: 1200 bps 1: 2400 bps 2: 4800 bps 3: 9600 bps 4: 19200 bps 5: 38400 bps 6: 57600 bps 7: 76800 bps 8: 115200 bps Note: Cycle power for the setting to take effect.
H5-03	Communication Parity Selection	0: No parity 1: Even parity 2: Odd parity Note: Cycle power for the setting to take effect.
H5-04	Stopping Method After Communication Error (CE)	0: Ramp to stop 1: Coast to stop 2: Fast Stop 3: Alarm only 4: Run at d1-04
H5-05	Communication Fault Detection Selection	0: Disabled 1: Enabled. If communication is lost for more than two seconds, a CE fault will occur.
H5-06	Drive Transmit Wait Time	Set the wait time between receiving and sending data. Note: Cycle power for the setting to take effect.
H5-07	RTS Control Selection	0: Disabled. RTS is always on. 1: Enabled. RTS turns on only when sending. Note: Cycle power for the setting to take effect.
H5-08	Communication Protocol Selection	0: MEMOBUS/Modbus 1: N2 (Metasys) 2: P1 (APOGEE FLN) 3: BACnet
H5-09	CE Detection Time	Sets the time required to detect a communications error. Adjustment may be needed when networking several drives.

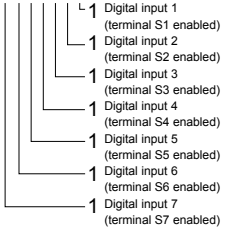
No.	Name	Description
H5-10	Unit Selection for MEMOBUS/Modbus Register 0025H	0: 0.1 V units 1: 1 V units
H5-11	Communications ENTER Function Selection	0: Drive requires an Enter command before accepting any changes to parameter settings. 1: Parameter changes are activated immediately without the Enter command.
H5-12	Run Command Method Selection	0: FWD/Stop, REV/Stop 1: Run/Stop, FWD/REV
L1-01	Motor Overload Protection Selection	0: Disabled 1: General purpose motor (standard fan cooled) 4: PM motor with variable torque Default setting is determined by parameter A1-02, Control Method Selection.
L1-02	Motor Overload Protection Time	Sets the motor thermal overload protection (oL1) time.
L1-03	Motor Overheat Alarm Operation Selection (PTC input)	Sets operation when the motor temperature analog input (H3-02 or H3-10 = E) exceeds the alarm level. 0: Ramp to stop 1: Coast to stop 2: Fast Stop (decelerate to stop using the deceleration time in C1-09) 3: Alarm only ("oH3" will flash)
L1-04	Motor Overheat Fault Operation Selection (PTC input)	Sets stopping method when the motor temperature analog input (H3-02, or H3-10 = E) exceeds the oH4 fault level. 0: Ramp to stop 1: Coast to stop 2: Fast Stop (decelerate to stop using the deceleration time in C1-09)
L1-05	Motor Temperature Input Filter Time (PTC input)	Adjusts the filter for the motor temperature analog input (H3-02, or H3-10 = E).
L1-08	oL1 Current Level	Sets the reference current for motor thermal overload detection for the motor in amperes.
L1-13	Continuous Electrothermal Operation Selection	0: Disabled 1: Enabled 2: Enable using Real Time Clock
L2-01	Momentary Power Loss Operation Selection	0: Disabled. Drive trips on Uv1 fault when power is lost. 1: Recover within the time set in L2-02. Uv1 will be detected if power loss is longer than L2-02. 2: Recover as long as CPU has power. Uv1 is not detected.
L2-02	Momentary Power Loss Ride-Thru Time	Sets the Power Loss Ride-Thru time. Enabled only when L2-01 = 1.
L2-03	Momentary Power Loss Minimum Baseblock Time	Sets the minimum wait time for residual motor voltage decay before the drive output reenergizes after performing Power Loss Ride-Thru. Increasing the time set to L2-03 may help if overcurrent or overvoltage occur during Speed Search or during DC Injection Braking. Note: Default setting is dependent upon parameter o2-04, Drive Model Selection.
L4-05	Frequency Reference Loss Detection Selection	0: Stop. Drive stops when the frequency reference is lost. 1: Run. Drive continues operation according to the setting of L4-06.
L4-06	Frequency Reference at Reference Loss	Sets the percentage of the frequency reference that the drive should run with when the frequency reference is lost.

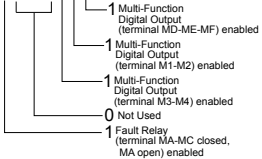
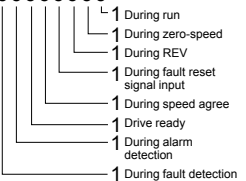
No.	Name	Description	No.	Name	Description
L5-01	Number of Auto Restart Attempts	Sets the number of times the drive may attempt to restart after the following faults occur: GF, LF, oC, ov, PF, oL1, oL2, oL3, STo, Uv1.	L8-06	Input Phase Detection Level	When ripple is observed in the DC bus, expansion of the input bias is calculated. This value becomes the input phase if the difference between the maximum and minimum values of the ripple is greater than the value set to L8-06. Detection Level = 100% = Voltage class x $\sqrt{2}$
L5-02	Auto Restart Fault Output Operation Selection	0: Fault output not active. 1: Fault output active during restart attempt.	L8-07	Output Phase Loss Protection Selection	0: Disabled 1: Enabled (triggered by a single phase loss) 2: Enabled (triggered when two phases are lost)
L5-03	Time to Continue Making Fault Restarts	Enabled only when L5-05 is set to 0. Causes a fault if a fault restart cannot occur after the set time passes.	L8-09	Output Ground Fault Detection Selection	0: Disabled 1: Enabled Note: Default setting is dependent upon parameter o2-04, Drive Model Selection.
L5-04	Fault Reset Interval Time	Sets the amount of time to wait between performing fault restarts.	L8-10	Heatsink Cooling Fan Operation Selection	0: Disabled 1: Enabled Note: Default setting is dependent upon parameter o2-04, Drive Model Selection.
L5-05	Fault Reset Operation Selection	0: Continuously attempt to restart while incrementing restart counter only at a successful restart. 1: Attempt to restart with the interval time set in L5-04 and increment the restart counter with each attempt.	L8-10	Heatsink Cooling Fan Operation Selection	0: During run only. Fan operates only during run for L8-11 seconds after stop. 1: Fan always on. Cooling fan operates whenever the drive is powered up.
L6-01	Torque Detection Selection 1	0: Disabled 1: oL3 detection only active during speed agree, operation continues after detection 2: oL3 detection always active during run, operation continues after detection 3: oL3 detection only active during speed agree, output shuts down on an oL3 fault 4: oL3 detection always active during run, output shuts down on an oL3 fault 5: UL3 detection only active during speed agree, operation continues after detection 6: UL3 detection always active during run, operation continues after detection 7: UL3 detection only active during speed agree, output shuts down on an oL3 fault 8: UL3 detection always active during run, output shuts down on an oL3 fault 9: UL6 at speed agree (alarm) 10: UL6 at run (alarm) 11: UL6 at speed agree (fault) 12: UL6 at run (fault)	L8-11	Heatsink Cooling Fan Off Delay Time	Sets a delay time to shut off the cooling fan after the Run command is removed when L8-10 = 0.
L6-02	Torque Detection Level 1	Sets the overtorque and undertorque detection level.	L8-12	Ambient Temperature Setting	Enter the ambient temperature. This value adjusts the oL2 detection level.
L6-03	Torque Detection Time 1	Sets the time an overtorque or undertorque condition must exist to trigger torque detection 1.	L8-15	oL2 Characteristics Selection at Low Speeds	0: No oL2 level reduction below 6 Hz. 1: oL2 level is reduced linearly below 6 Hz. It is reduced to 70% at 0 Hz
L6-13	Motor Underload Protection Selection	0: Overtorque/undertorque detection enabled 1: Base frequency motor load enabled	L8-18	Software Current Limit Selection	0: Disabled 1: Enabled
L6-14	Motor Underload Protection Level at Minimum Frequency	Sets the UL6 detection level at minimum frequency by percentage of drive rated current.	L8-19	Frequency Reduction Rate during Overheat Pre-Alarm	Specifies the frequency reference reduction gain at overheat pre-alarm when L8-03 = 4.
L8-02	Overheat Alarm Level	An overheat alarm occurs when heatsink temperature exceeds the L8-02 level.	L8-27	Overcurrent Detection Gain	Sets the gain for overcurrent detection as a percentage of the motor rated current. Overcurrent is detected using the lower value between the overcurrent level of the drive or the value set to L8-27.
L8-03	Overheat Pre-Alarm Operation Selection	0: Ramp to stop. A fault is triggered. 1: Coast to stop. A fault is triggered. 2: Fast Stop. Decelerate to stop using the deceleration time in C1-09. A fault is triggered. 3: Continue operation. An alarm is triggered. 4: Continue operation at reduced speed as set in L8-19.	L8-29	Current Unbalance Detection (LF2)	0: Disabled 1: Enabled
L8-05	Input Phase Loss Protection Selection	Selects the detection of input current phase loss, power supply voltage imbalance, or main circuit electrolytic capacitor deterioration. 0: Disabled 1: Enabled	L8-32	Main Contactor and Cooling Fan Power Supply Failure Selection	0: Ramp to stop 1: Coast to stop 2: Fast stop (Decelerate to stop using the deceleration time set to C1-09) 3: Alarm only ("FAn" will flash) 4: Continue operation at reduced speed as set to L8-19.
			L8-35	Installation Method Selection	0: IP00/Open-Chassis enclosure 2: IP20/UL Type 1 enclosure 3: External Heatsink Installation Note: Default setting is dependent upon parameter o2-04, Drive Model Selection.
			L8-38	Carrier Frequency Reduction	0: Disabled 1: Enabled below 6 Hz 2: Enabled for the entire speed range Note: Default setting is dependent upon parameters A1-02, Control Method Selection, and o2-04, Drive Model Selection.
			L8-40	Carrier Frequency Reduction Off Delay Time	Sets the time that the drive continues running with reduced carrier frequency after the carrier reduction condition is gone. Setting 0.00 s disables the carrier frequency reduction time.
			L8-41	High Current Alarm Selection	0: Disabled 1: Enabled. An alarm is triggered at output currents above 150% of drive rated current.

i.8 Parameter Table

No.	Name	Description
o1-01	Drive Mode Unit Monitor Selection	Selects the content of the last monitor that is shown when scrolling through Drive Mode display. Enter the last three digits of the monitor parameter number to be displayed: U□-□□.
o1-02	User Monitor Selection after Power Up	1: Frequency reference (U1-01) 2: Direction 3: Output frequency (U1-02) 4: Output current (U1-03) 5: User Monitor
o1-03	HOA Keypad Operator Display Selection	0: 0.01 Hz 1: 0.01% (100% = E1-04) 2: r/min (calculated using the number of motor poles setting in E2-04, E4-04, or E5-04) 3: User-selected units (set by o1-10 and o1-11)
o1-06	User Monitor Selection Mode	0: 3 Monitor Sequential (Displays the next two sequential monitors) 1: 3 Monitor Selectable (o1-07 and o1-08 selected monitor are shown)
o1-07	Second Line Monitor Selection	Selects the monitor that is shown in the second line.
o1-08	Third Line Monitor Selection	Selects the monitor that is shown in the third line.
o1-09	Frequency Reference Display Units	Sets unit display for the frequency reference parameters and frequency related monitors when o1-03 > 40. 0: WC (Inch of water) 1: PSI (Pounds per square inch) 2: GPM (Gallons per minute) 3: F (Degrees Fahrenheit) 4: CFM (Cubic feet per minute) 5: CMH (Cubic meters per hour) 6: LPH (Liters per hour) 7: LPS (Liters per second) 8: Bar (Bar) 9: Pa (Pascal) 10: C (Degrees Celsius) 11: Mtr (Meters) 12: Ft (Feet) 13: LPM (Liters per minute) 14: CMM (Cubic meters per minute) 15: Custom units (Determined by o1-12) 16: No unit
o1-10	User-Set Display Units Maximum Value	These settings define the display values when o1-03 is set to 3.
o1-11	User-Set Display Units Decimal Display	o1-10 sets the display value that is equal to the maximum output frequency. o1-11 sets the position of the decimal position.
o1-13	Frequency Reference and Frequency Related Monitor Custom Units 1	Sets the customer-specified unit display for the frequency reference parameters and frequency related monitors when o1-03 = 3 and o1-09 = 15 as custom units.
o1-14	Frequency Reference and Frequency Related Monitor Custom Units 2	Sets the customer-specified unit display for the frequency reference parameters and frequency related monitors when o1-03 = 3 and o1-09 = 15 as custom units
o1-15	Frequency Reference and Frequency Related Monitor Custom Units 3	Sets the customer-specified unit display for the frequency reference parameters and frequency related monitors when o1-03 = 3 and o1-09 = 15 as custom units
o1-16	F1 Key Function Selection	0: Standard 1: Monitor 2: Drive/Bypass (DRV/BYP) 3: Bypass Run Command (RUN BYP) 4: Toggle Relay Output (RLY)
o1-17	F2 Key Function Selection	0: Standard 1: Monitor 2: Drive/Bypass (DRV/BYP) 3: Bypass Run Command (RUN BYP) 4: Toggle Relay Output (RLY)

No.	Name	Description
o1-18	User Defined Parameter Upper	Allows the user to set values that can be used as reference information.
o1-19	User Defined Parameter Lower	Allows the user to set values that can be used as reference information.
o2-02	OFF Key Function Selection	0: Disabled. OFF key is disabled in REMOTE operation. 1: Enabled. OFF key is always enabled.
o2-03	User Parameter Default Value	0: No change 1: Set defaults. Saves parameter settings as default values for a User Initialization. 2: Clear all. Clears the default settings that have been saved for a User Initialization.
o2-04	Drive Model Selection	Enter the drive model. Setting required only if installing a new control board.
o2-05	Frequency Reference Setting Method Selection	0: ENTER key must be pressed to enter a frequency reference. 1: ENTER key is not required. The frequency reference can be adjusted using the up and down arrow keys only.
o2-06	Operation Selection when HOA Keypad is Disconnected	0: The drive continues operating if the HOA keypad is disconnected. 1: An oPr fault is triggered and the motor coasts to stop.
o2-07	Motor Direction at Power Up when Using Operator	0: Forward 1: Reverse This parameter requires assigning drive operation to the HOA keypad.
o2-19	Selection of Parameter Write During UV	Selects whether parameter settings can be changed during a control circuit undervoltage condition. Used with built-in 24 V Power Supply Unit models. 0: Forward 1: Reverse
o3-01	Copy Function Selection	0: No action 1: Read parameters from the drive, saving them onto the HOA keypad. 2: Copy parameters from the HOA keypad, writing them to the drive. 3: Verify parameter settings on the drive to check if they match the data saved on the HOA keypad.
o3-02	Copy Allowed Selection	0: Read operation prohibited 1: Read operation allowed
o4-01	Cumulative Operation Time Setting	Sets the value for the cumulative operation time of the drive in units of 10 h.
o4-02	Cumulative Operation Time Selection	0: Logs power-on time 1: Logs operation time when the drive output is active (output operation time).
o4-03	Cooling Fan Operation Time Setting	Sets the value of the fan operation time monitor U4-03 in units of 10 h.
o4-05	Capacitor Maintenance Setting	Sets the value of the Maintenance Monitor for the capacitors. See U4-05 to check when the capacitors may need to be replaced.
o4-07	DC Bus Pre-Charge Relay Maintenance Setting	Sets the value of the Maintenance Monitor for the soft charge bypass relay. See U4-06 to check when the bypass relay may need to be replaced.
o4-11	U2, U3 Initialization	0: U2-□□ and U3-□□ monitor data is not reset when the drive is initialized (A1-03). 1: U2-□□ and U3-□□ monitor data is reset when the drive is initialized (A1-03).
o4-12	kWh Monitor Initialization	0: U4-10 and U4-11 monitor data is not reset when the drive is initialized (A1-03). 1: U4-10 and U4-11 monitor data is reset when the drive is initialized (A1-03).

No.	Name	Description
o4-13	Number of Run Commands Counter Initialization	0: Number of Run commands counter is not reset when the drive is initialized (A1-03). 1: Number of Run commands counter is reset when the drive is initialized (A1-03).
o4-17	Set/Reset Real Time Clock	0: — No Setting 1: Real Time Clock Set 2: Real Time Clock Reset
T1-01	Auto-Tuning Mode Selection	2: Stationary Auto-Tuning for Line-to-Line Resistance 3: Rotational Auto-Tuning for V/f Control Energy Saving
T1-02	Motor Rated Power	Sets the motor rated power as specified on the motor nameplate.
T1-03	Motor Rated Voltage	Sets the motor rated voltage as specified on the motor nameplate.
T1-04	Motor Rated Current	Sets the motor rated current as specified on the motor nameplate.
T1-05	Motor Base Frequency	Sets the rated frequency of the motor as specified on the motor nameplate.
T1-06	Number of Motor Poles	Sets the number of motor poles as specified on the motor nameplate.
T1-07	Motor Base Speed	Sets the rated speed of the motor as specified on the motor nameplate.
T1-11	Motor Iron Loss	Sets the iron loss for determining the Energy Saving coefficient.
T1-12	T1 Tuning Start	The drive starts tuning.
U1-01	Frequency Reference	Monitors the frequency reference. Display units are determined by o1-03.
U1-02	Output Frequency	Displays the output frequency. Display units are determined by o1-03.
U1-03	Output Current	Displays the output current.
U1-06	Output Voltage Reference	Displays the output voltage.
U1-10	Input Terminal Status	Displays the input terminal status. U1 - 10= 00000000 

No.	Name	Description
U1-11	Output Terminal Status	Displays the output terminal status. U1 - 11= 00000000 
U1-12	Drive Status	Verifies the drive operation status. U1 - 12= 00000000 
U1-13	Terminal A1 Input Level	Displays the signal level to analog input terminal A1.
U1-14	Terminal A2 Input Level	Displays the signal level to analog input terminal A2.
U1-15	Terminal A3 Input Level	Displays the signal level to analog input terminal A3.
U1-54	Drive Input Power Voltage Effective Value	Displays the effective value of the drive input power voltage.
U1-58	Power Supply Frequency	Displays the frequency of the drive input power supply.
U5-01	PID Feedback	Displays the PID feedback value.
U5-02	PID Input	Displays the amount of PID input (deviation between PID setpoint and feedback).
U5-03	PID Output	Displays PID control output.
U5-04	PID Setpoint	Displays the PID setpoint.

i.9 Standards Compliance

◆ European Standards



Figure i.57 CE Mark

The CE mark indicates that a product is in compliance with applicable European Directives for safety and environmental regulations. It is required for engaging in business and commerce in Europe.

The applicable European Directives for this product are as follows. We declared the CE marking based on the harmonized standards in [Table i.32](#).

Table i.32 European Directives

Applicable European Directive	Applicable Harmonized Standards
Low Voltage Directive (2014/35/EU)	IEC/EN 61800-5-1: 2007
EMC Guidelines (2014/30/EU)	EN 61800-3:2004+A1:2012

The user(s) is solely responsible for ensuring that the end products used with this drive comply with all applicable European directives and with other national regulations (if required).

◆ CE Low Voltage Directive Compliance

This drive has been tested according to European standard IEC/EN 61800-5-1:2007, and it fully complies with the Low Voltage Directive.

To comply with the Low Voltage Directive, be sure to meet the following conditions when combining this drive with other devices:

■ Area of Use

Do not use drives in areas with pollution higher than degree 2 and overvoltage category 3 in accordance with IEC/EN 60664.

■ Grounding

The drive is designed to be used in T-N (grounded neutral point) networks. If installing the drive in other types of grounded systems, contact your Yaskawa representative for instructions.

■ Guarding Against Harmful Materials

When installing IP00/Open Type enclosure drives, use an enclosure that prevents foreign material from entering the drive from above or below.

◆ EMC Guidelines Compliance

When EMC is a concern for drives with internal EMC filters and the network is grounded symmetrically, install the EMC filter screw to the ON position and enable the internal EMC filter.

Drives ship from the factory with EMC filter screws installed in the OFF position.

Drives with internal EMC filters (Z□□E□□□□ and Z□□W□□□□) are tested according to European standards IEC/EN 61800-3: 2004+A1: 2012 and comply with EMC guidelines.

Note: Drives with customized specifications A and P are not compatible. [Refer to Model Number on page 14](#) for details on customized specifications.

■ Internal EMC Filter Installation

Installation Method

Verify the following installation conditions to ensure that other devices and machinery used in combination with drive models Z□□E□□□□ and Z□□W□□□□ also comply with EMC guidelines.

1. Place the drive in the enclosure.

2. Use braided shield cable for the drive and motor wiring, or run the wiring through a metal conduit.
3. Keep wiring as short as possible. Ground the shield on both the drive side and the motor side.

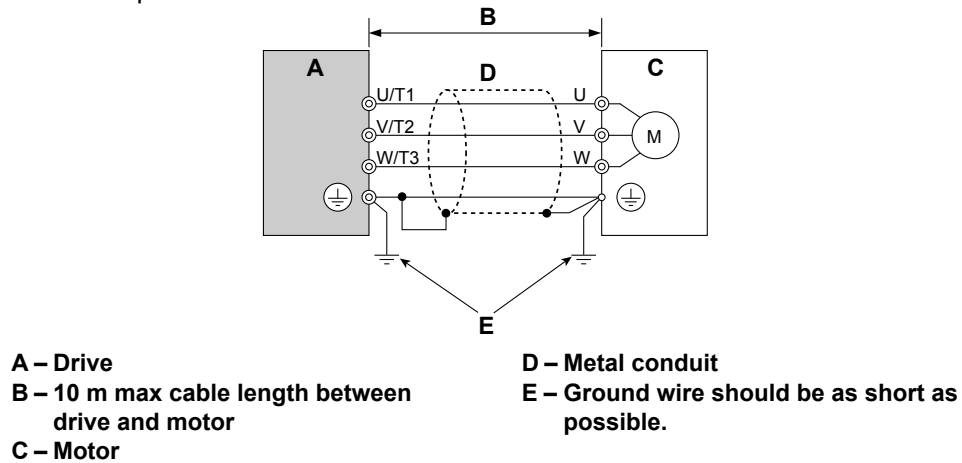


Figure i.58 Installation Method

4. Make sure the protective earthing conductor complies with technical standards and local safety regulations.

WARNING! *Electrical Shock Hazard. Because the leakage current exceeds 3.5 mA in models 4□0302 and larger, IEC/EN 61800-5-1:2007 states that either the power supply must be automatically disconnected in case of discontinuity of the protective earthing conductor, or a protective earthing conductor with a cross-section of at least 10 mm² (Cu) or 16 mm² (Al) must be used. Failure to comply may result in death or serious injury.*

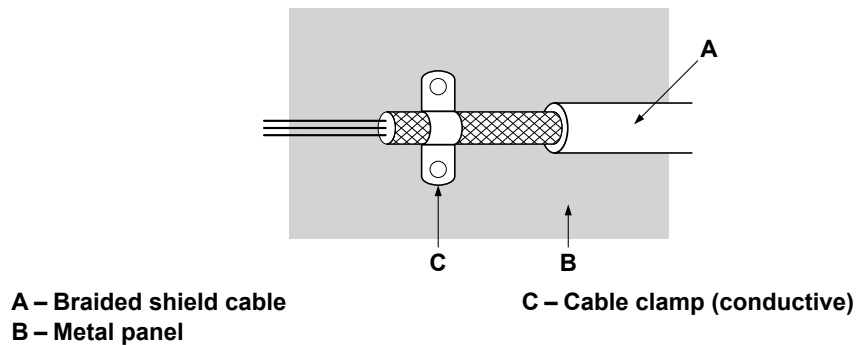


Figure i.59 Ground Area

i.9 Standards Compliance

Three-Phase 200 V / 400 V Class

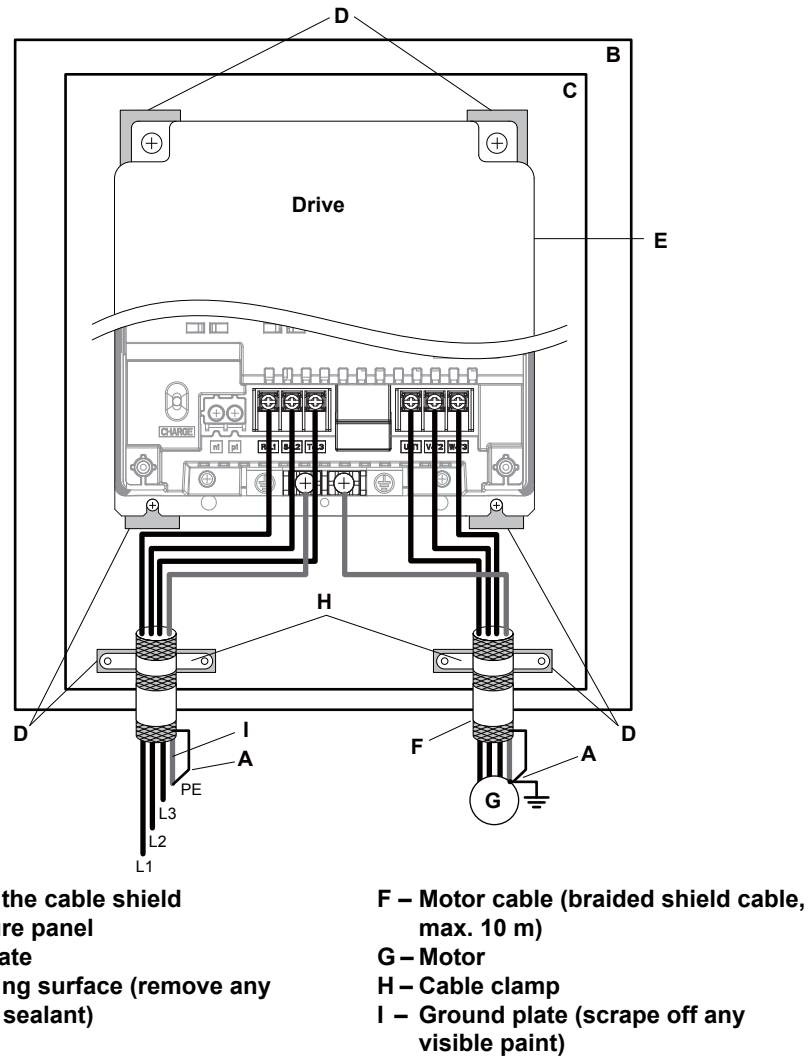


Figure i.60 Internal EMC Filter and Drive Installation for CE Compliance (Three-Phase 200 V / 400 V Class)

◆ UL Standards Compliance

The UL/cUL mark applies to products in the United States and Canada. It indicates that UL has performed product testing and evaluation, and determined that their stringent standards for product safety have been met. For a product to receive UL certification, all components inside that product must also receive UL certification.



Figure i.61 UL/cUL Mark

This drive is tested in accordance with UL standard UL 61800-5-1 and complies with UL requirements. The conditions described below must be met to maintain compliance when using this drive in combination with other equipment:

■ Conditions of Acceptability

Install the drive and peripherals in a suitable enclosure for end use.

■ Installation Area

Do not install the drive to an area greater than pollution degree 2 (UL standard).

■ Ambient Temperature

IP00/Open Type Enclosure: -10 °C to +50 °C (14 °F to 122 °F)

IP20/UL Type 1 Enclosure: -10 to +40 °C (14 °F to 104 °F)

Finless Type: IP20/IP00 Enclosure: -10 to +45 °C (14 °F to 113 °F)

■ Main Circuit Terminal Wiring

Yaskawa recommends using closed-loop crimp terminals on all drive models. Use only the tools recommended by the terminal manufacturer for crimping. [Refer to Closed-Loop Crimp Terminal Recommendations on page 83](#) for closed-loop crimp terminal recommendations.

The wire gauges listed in the following tables are Yaskawa recommendations. Refer to local codes for proper wire gauge selections.

Note: The ⊕ mark indicates the terminals for protective ground connection.
 Grounding impedance:
 200 V: 100 Ω or less
 400 V: 10 Ω or less

Wire Gauges and Tightening Torques

[Refer to Main Circuit Wire Gauges and Tightening Torque on page 23.](#)

■ Closed-Loop Crimp Terminal Recommendations

Yaskawa recommends crimp terminals made by JST and Tokyo DIP (or equivalent) for the insulation cap. [Table i.33](#) matches the wire gauges and terminal screw sizes with Yaskawa-recommended crimp terminals, tools, and insulation caps. Use the appropriate wire gauge and screw size for your drive model. Place orders with a Yaskawa representative or the Yaskawa sales department. Select suitable crimp terminals in accordance with national, state, or local codes.

Drive Models 2□0028 to 2□0248 and 4□0011 to 4□0414

Table i.33 Closed-Loop Crimp Terminal Size

Drive Model	Wire Gauge (AWG, kcmil) R/L1, S/L2, T/L3 U/T1, V/T2, W/T3	Screw Size	Crimp Terminal Model Number	Tool		Insulation Cap Model No.	Code <1>
				Machine No.	Die Jaw		
200 V Class							
2□0028	10	M5	R5.5-5	YA-4	AD-900	TP-005	100-054-030
	8 <2>		R8-5		AD-901	TP-008	100-054-032
2□0042	8	M6	R8-6	YA-4	AD-901	TP-008	100-065-184
	6 <2>		R14-6		AD-902	TP-014	100-051-261
	4		R22-6	YA-5	AD-953	TP-022	100-051-262
	3		R22-6		AD-952	TP-014	100-051-261
2□0054	6	M6	R14-6	YA-5	AD-953	TP-022	100-051-262
	4 <2>		R22-6		AD-952	TP-014	100-051-261
	3						
2□0068	4 <2>	M6	R22-6	YA-5	AD-953	TP-022	100-051-262
	3						
2□0081	6 <2>	M6	R14-6	YA-5	AD-952	TP-014	100-051-261
	4		R22-6		AD-953	TP-022	100-051-262
	3						

i.9 Standards Compliance

Drive Model	Wire Gauge (AWG, kcmil)	Screw Size	Crimp Terminal Model Number	Tool		Insulation Cap Model No.	Code <?>				
	R/L1, S/L2, T/L3 U/T1, V/T2, W/T3			Machine No.	Die Jaw						
2□0104	6	M8	R14-8	YA-4	AD-902	TP-014	100-054-035				
	4		R22-8	YA-5	AD-953	TP-022	100-051-263				
	3										
	2										
	1 <?>										
1/0	R60-8	AD-955	TP-060	100-051-265							
2□0130	6	M8	R14-8	YA-5	AD-952	TP-014	100-054-035				
	4 <?>		R22-8		AD-953	TP-022	100-051-263				
	3										
	2										
	1										
1/0	R60-8	AD-955	TP-060	100-0051-265							
2□0154	4	M10	R22-10	YA-5	AD-953	TP-022	100-061-113				
	3 <?>										
	2										
	1		R38-10	AD-954	TP-038	100-061-114					
	1/0										
	2/0						70-10	YF-1 YET-300-1	TD-322 TD-311	TP-080	100-064-251
	3/0										
4/0	80-10	TD-323 TD-312	100-051-267								
2□0192	3	M10	R22-10	YA-5	AD-953	TP-022	100-061-113				
	2		R38-10		AD-954	TP-038	100-061-114				
	1 <?>										
	1/0		R60-10	AD-955	TP-060	100-051-266					
	2/0		70-10	YF-1 YET-300-1	TD-322 TD-311	TP-080	100-064-251				
	3/0		80-10					TD-323 TD-312	100-051-267		
	4/0		R100-10					TD-324 TD-312	TP-100	100-051-269	
2□0248	1	M10	R38-10					YA-5	AD-954	TP-038	100-061-114
	1/0		R60-10	YF-1 YET-300-1	TD-321 TD-311	TP-060	100-051-266				
	2/0 <?>		70-10					TD-322 TD-311	TP-080	100-064-251	
	3/0		80-10					TD-323 TD-312			100-051-267
	4/0		R100-10					TD-324 TD-312	TP-100	100-051-269	
400 V Class											
4□0011	14 <?>	M5	R2-5	YA-4	AD-900	TP-003	100-123-030				
	12		R5.5-5			AD-901	TP-008	100-054-032			
	10										
	8										
4□0014	14	M5	R2-5	YA-4	AD-900	TP-003	100-123-030				
	12 <?>		R5.5-5			AD-901	TP-008	100-054-032			
	10										
	8										

Drive Model	Wire Gauge (AWG, kcmil)	Screw Size	Crimp Terminal Model Number	Tool		Insulation Cap Model No.	Code <1>		
	R/L1, S/L2, T/L3 U/T1, V/T2, W/T3			Machine No.	Die Jaw				
4□0021	12	M5	R5.5-5	YA-4	AD-900	TP-005	100-054-030		
	10 <2>								
	8		R8-5		AD-901			TP-008	100-054-032
4□0027	10	M5	R5.5-5	YA-4	AD-900	TP-005	100-054-030		
	8 <2>		R8-5		AD-901	TP-008	100-054-032		
4□0034	8 <2>	M5	R8-5	YA-4	AD-901	TP-008	100-054-032		
4□0040	8 <2>	M6	R8-6	YA-4	AD-901	TP-008	100-065-184		
	6		R14-6		AD-902	TP-014	100-051-261		
	4	M6	R22-6	YA-5	AD-953	TP-022	100-051-262		
	3								
4□0052	8	M6	R8-6	YA-4	AD-901	TP-008	100-065-184		
	6 <2>		R14-6		AD-902	TP-014	100-051-261		
	4	M6	R22-6	YA-5	AD-953	TP-022	100-051-262		
	3								
4□0065	6	M6	R14-6	YA-5	AD-952	TP-014	100-051-261		
	4 <2>		R22-6		AD-953	TP-022	100-051-262		
	3								
4□0077	4	M6	R22-6	YA-5	AD-953	TP-022	100-051-262		
	3 <2>								
4□0096	8	M8	R8-8	YA-4	AD-901	TP-008	100-601-111		
	6		R14-8		AD-902	TP-014	100-054-035		
	4		M8	R22-8	YA-5	AD-953	TP-022	100-051-263	
	3								
	2		M8	R38-8	YA-5	AD-954	TP-038	100-051-264	
	1 <2>								
1/0	M8	R60-8	YA-5	AD-955	TP-060	100-051-265			
6									
4□0124	6	M8	R14-8	YA-5	AD-952	TP-014	100-054-035		
	4 <2>		M8		R22-8	AD-953	TP-022	100-051-263	
	3								
	2		M8		R38-8	YA-5	AD-954	TP-038	100-051-264
	1								
	1/0		M8		R60-8	YA-5	AD-955	TP-060	100-051-265
6									
4□0156	4	M10	R22-10	YA-5	AD-953	TP-022	100-061-113		
	3 <2>								
	2								
	1		M10	R38-10	YA-5	AD-954	TP-038	100-061-114	
	1/0								
	2/0		M10	R60-10	YA-5	AD-955	TP-060	100-051-266	
	3/0								
	4/0								
4□0156	2/0	M10	70-10	YF-1 YET-300-1	TD-322 TD-311	TP-080	100-064-251		
	3/0		80-10		TD-323 TD-312		100-051-267		
4□0156	4/0	M10	R100-10	YF-1 YET-300-1	TD-324 TD-312	TP-100	100-051-269		

i.9 Standards Compliance

Drive Model	Wire Gauge (AWG, kcmil)	Screw Size	Crimp Terminal Model Number	Tool		Insulation Cap Model No.	Code <1>
	R/L1, S/L2, T/L3 U/T1, V/T2, W/T3			Machine No.	Die Jaw		
4□0180	3	M10	R22-10	YA-5	AD-953	TP-022	100-061-113
	2 <2>		R38-10		AD-954	TP-038	100-061-114
	1		R60-10		AD-955	TP-060	100-051-266
	1/0		70-10	YF-1 YET-300-1	TD-322 TD-311	TP-080	100-064-251
	2/0		80-10		TD-323 TD-312		100-051-267
	3/0		R100-10		TD-324 TD-312	TP-100	100-051-269
	4/0						
4□0216	2	M10	R38-10	YA-5	AD-954	TP-038	100-061-114
	1		R60-10	YF-1 YET-300-1	TD-321 TD-311	TP-060	100-051-266
	1/0 <2>		70-10		TD-322 TD-311	TP-080	100-064-251
	2/0		80-10		TD-323 TD-312		100-051-267
	3/0		R100-10		TD-324 TD-312	TP-100	100-051-269
	4/0						
4□0240	1/0 <2>	M10	R60-10	YF-1 YET-300-1	TD-321 TD-311	TP-060	100-051-266
	2/0		70-10		TD-322 TD-311	TP-080	100-064-251
	3/0		80-10		TD-323 TD-312		100-051-267
	4/0		R100-10		TD-324 TD-312	TP-100	100-051-269
4□0302	1/0	M10	R60-10	YF-1 YET-300-1	TD-321 TD-311	TP-060	100-051-266
	2/0		70-10		TD-322 TD-311	TP-080	100-064-251
	3/0 <2>		80-10		TD-323 TD-312		100-051-267
	4/0		R100-10		TD-324 TD-312	TP-100	100-051-269
4□0361	3/0	M10	80-10	YF-1 YET-300-1	TD-323 TD-312	TP-080	100-051-267
	4/0 <2>		R100-10		TD-324 TD-312	TP-100	100-051-269
4□0414	4/0	M12	R100-12	YF-1 YET-300-1	TD-324 TD-312	TP-100	100-051-270
	250		R150-12		TD-325 TD-313	TP-150	100-051-273
	300 <2>						

<1> Codes refer to a set of three crimp terminals and three insulation caps. Prepare input and output wiring using two sets for each connection.

<2> Recommended wire gauges. Refer to local codes for proper selections.

Note: Use crimp insulated terminals or insulated shrink tubing for wiring connections. Wires should have a continuous maximum allowable temperature of 75 °C (167 °F) 600 Vac UL-approved vinyl-sheathed insulation.

■ Low Voltage Wiring for Control Circuit Terminals

Wire low voltage wires with NEC Class 1 circuit conductors. Refer to national state or local codes for wiring. The external power supply shall be a UL Listed Class 2 power supply source or equivalent only.

Table i.34 Control Circuit Terminal Power Supply

Input / Output	Terminal Signal	Power Supply Specifications
Multi-function digital inputs	S1 to S8, SC	Use the internal LVLC power supply of the drive or an external class 2 power supply.
Multi-function analog inputs	+V, A1, A2, A3, AC, FM, AM	

■ Drive Short Circuit Rating

The drive is suitable for use on a circuit capable of delivering not more than 100,000 RMS symmetrical amperes, 240 Vac maximum (200 V class), 480 Vac maximum (400 V class: 4E□□□□ and 4W□□□□), and 500 Vac maximum (400 V class: 4U□□□□ and 4P□□□□) with built-in fuses manufactured by Hinode Electric Co., Ltd. and Mersen (or equivalent).

◆ Drive Motor Overload Protection

Set parameter E2-01 (motor rated current) to the appropriate value to enable motor overload protection. The internal motor overload protection is UL Listed and in accordance with the NEC and CEC.

■ Branch Circuit Protection

For installation in the United States, provide branch circuit protection in accordance with the National Electrical Code (NEC) and any applicable local codes.

For installation in Canada, provide branch circuit protection in accordance with the Canadian Electrical Code and any applicable provincial codes.

■ E2-01: Motor Rated Current

Setting Range: 10% to 150% of the drive rated current

Default Setting: Model-dependent

Parameter E2-01 protects the motor when parameter L1-01 is not set to 0. The default for L1-01 is 1, which enables protection for standard induction motors.

If Auto-Tuning has been performed successfully, the motor data entered to T1-04 and T2-06 are automatically written to parameter E2-01. If Auto-Tuning has not been performed, manually enter the correct motor rated current to parameter E2-01.

■ L1-01: Motor Overload Protection Selection

The drive has an electronic overload protection function (oL1) based on time, output current, and output frequency that protects the motor from overheating. The electronic thermal overload function is UL-recognized, so it does not require an external thermal relay for single motor operation.

This parameter selects the motor overload curve used according to the type of motor applied.

Table i.35 Overload Protection Settings

Setting	Description	
0	Disabled	Disabled the internal motor overload protection of the drive.
1	Standard fan-cooled motor (default)	Selects protection characteristics for a standard self-cooled motor with limited cooling capabilities when running below the rated speed. The motor overload detection level (oL1) is automatically reduced when running below the motor rated speed.
4	Permanent Magnet motor with variable torque	Selects protection characteristics for a variable torque PM motor. The motor overload detection level (oL1) is automatically reduced when running below the motor rated speed.

When connecting the drive to more than one motor for simultaneous operation, disable the electronic overload protection (L1-01 = 0) and wire each motor with its own motor thermal overload relay.

Enable motor overload protection (L1-01 = 1 or 4) when connecting the drive to a single motor, unless another motor overload preventing device is installed. The drive electronic thermal overload function causes an oL1 fault, which shuts off the output of the drive and prevents additional overheating of the motor. The motor temperature is continually calculated while the drive is powered up.

■ L1-02: Motor Overload Protection Time

Setting Range: 0.1 to 5.0 min

Factory Default: 1.0 min

i.9 Standards Compliance

Parameter L1-02 determines how long the motor is allowed to operate before the oL1 fault occurs when the drive is running a hot motor at 60 Hz and at 150% of the full load amp rating (E2-01) of the motor. Adjusting the value of L1-02 can shift the set of oL1 curves up the y axis of the diagram below, but will not change the shape of the curves.

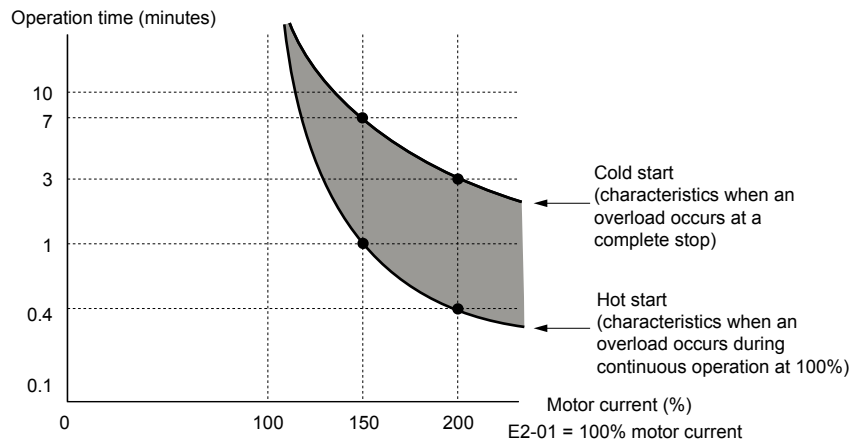


Figure i.62 Motor Overload Protection Time

■ L1-03: Motor Overheat Alarm Operation Selection (PTC input)

Sets the drive operation when the PTC input signal reaches the motor overheat alarm level (oH3).

No.	Name	Setting Range	Default
L1-03	Motor Overheat Alarm Operation Selection (PTC input)	0 to 3	3

Setting 0: Ramp to Stop

The drive stops the motor using the deceleration time 1 set in parameter C1-02.

Setting 1: Coast to Stop

The drive output is switched off and the motor coasts to stop.

Setting 2: Fast Stop

The drive stops the motor using the Fast Stop time set in parameter C1-09.

Setting 3: Alarm Only

The operation is continued and an oH3 alarm is displayed on the digital operator.

■ L1-04: Motor Overheat Fault Operation Selection (PTC input)

Sets the drive operation when the PTC input signal reaches the motor overheat fault level (oH4).

No.	Name	Setting Range	Default
L1-04	Motor Overheat Fault Operation Selection (PTC input)	0 to 2	1

Setting 0: Ramp to Stop

The drive stops the motor using the deceleration time 1 set in parameter C1-02.

Setting 1: Coast to Stop

The drive output is switched off and the motor coasts to stop.

Setting 2: Fast Stop

The drive stops the motor using the Fast Stop time set in parameter C1-09.

◆ CSA Standards Compliance

■ Conditions of Acceptability

Refer to Conditions of Acceptability on page 82 for details.

■ Branch Circuit Protection

For installation in Canada, branch circuit protection must be provided in accordance with the Canadian Electrical Code and any applicable provincial codes. To fulfill this requirement, use the UL classified fuses.

■ Main Circuit Terminal Wiring

Yaskawa recommends using closed-loop crimp terminals on all drive models. To maintain CSA approval, CSA Certified closed-loop crimp terminals are specifically required when wiring the drive main circuit terminals on models 2□0028 to 2□0248 and 4□0011 to 4□0414. Use only the tools recommended by the terminal manufacturer for crimping.

Refer to Closed-Loop Crimp Terminal Recommendations on page 83 for closed-loop crimp terminal recommendations. The wire gauges listed in the following tables are Yaskawa recommendations. Refer to local codes for proper wire gauge selections.

The external power supply shall be a CSA certified or cUL Listed Class 2 power source only or equivalent. Refer to *Table i.34* for details.

■ CSA for Industrial Control Equipment

The drive is CSA certified as Industrial Control Equipment Class 3211.

Specifically, the drive is certified to: CAN/CSA C22.2 No.0-10 and CAN/CSA C22.2 No.14-13.



Figure i.63 CSA Mark

Revision History

The revision dates and the numbers of the revised manuals appear on the bottom of the back cover.

Example:

MANUAL NO. TOEP C710636 11B <1>
 └─ Revision number
 Published in Japan October 2014
 └─ Date of publication

Date of Publication	Revision Number	Section	Revised Content
September 2019	<4>	Electrical Installation	Revision: Standard Connection Diagram
May 2017	<3>-1	Preface	Revision: Removed restrictions
August 2016	<3>	Front Cover	Revision: Format
		All	Revision: Upgraded the software version to PRG: 6114 Reviewed and corrected documentation
		Standards Compliance	Revision: CSA Standards Compliance
		Back Cover	Revision: Address, Format
January 2015	<2>	Front Cover	Revision: Models
		Receiving	Revision: Reference Motor Capacity kW (HP) values Figure i.4
		Back Cover	Revision: Address
October 2014	<1>	All	Revision: Upgraded the software version to PRG: 6113
		Front Cover Back Cover	Revision: Title
		Preface	Revision: Applicable Documentation
		Electrical Installation	Revision: EMC filter switch for models 2E0248, 2W0248, 4EU0216, 4W0216, 4E0240, and 4W0240
		Parameter Table	Addition: H2-06 = 0 (0.1 kWh units)
July 2014	–	–	First Edition. This manual supports drive software version PRG: 6112.

This Page Intentionally Blank

Low Harmonic Drive for HVAC Applications

Z1000U HVAC MATRIX Drive

Quick Start Guide

YASKAWA AMERICA, INC.

2121, Norman Drive South, Waukegan, IL 60085, U.S.A.
Phone: +1-800-YASKAWA (927-5292) or +1-847-887-7000 Fax: +1-847-887-7310
<http://www.yaskawa.com>

DRIVE CENTER (INVERTER PLANT)

2-13-1, Nishimiyaichi, Yukuhashi, Fukuoka, 824-8511, Japan
Phone: +81-930-25-2548 Fax: +81-930-25-3431
<http://www.yaskawa.co.jp>

YASKAWA ELECTRIC CORPORATION

New Pier Takeshiba South Tower, 1-16-1, Kaigan, Minatoku, Tokyo, 105-6891, Japan
Phone: +81-3-5402-4502 Fax: +81-3-5402-4580
<http://www.yaskawa.co.jp>

YASKAWA ELÉTRICO DO BRASIL LTDA.

777, Avenida Piraporinha, Diadema, São Paulo, 09950-000, Brasil
Phone: +55-11-3585-1100 Fax: +55-11-3585-1187
<http://www.yaskawa.com.br>

YASKAWA EUROPE GmbH

Hauptstraße 185, 65760 Eschborn, Germany
Phone: +49-6196-569-300 Fax: +49-6196-569-398
<http://www.yaskawa.eu.com> E-mail: info@yaskawa.eu.com

YASKAWA ELECTRIC KOREA CORPORATION

9F, Kyobo Securities Bldg., 97, Uisadang-daero, Yeongdeungpo-gu, Seoul, Korea 07327
Phone: +82-2-784-7844 Fax: +82-2-784-8495
<http://www.yaskawa.co.kr>

YASKAWA ELECTRIC (SINGAPORE) PTE. LTD.

151, Lorong Chuan, #04-02A, New Tech Park, 556741, Singapore
Phone: +65-6282-3003 Fax: +65-6289-3003
<http://www.yaskawa.com.sg>

YASKAWA ELECTRIC (THAILAND) CO., LTD.

59, 1st-5th Floor, Flourish Building, Soi Ratchadapisek 18, Ratchadapisek Road, Huaykwang, Bangkok, 10310, Thailand
Phone: +66-2-017-0099 Fax: +66-2-017-0799
<http://www.yaskawa.co.th>

YASKAWA ELECTRIC (CHINA) CO., LTD.

22F, One Corporate Avenue, No.222, Hubin Road, Shanghai, 200021, China
Phone: +86-21-5385-2200 Fax: +86-21-5385-3299
<http://www.yaskawa.com.cn>

YASKAWA ELECTRIC (CHINA) CO., LTD. BEIJING OFFICE

Room 1011, Tower W3 Oriental Plaza, No. 1, East Chang An Ave.,
Dong Cheng District, Beijing, 100738, China
Phone: +86-10-8518-4086 Fax: +86-10-8518-4082

YASKAWA ELECTRIC TAIWAN CORPORATION

9F, 16, Nanking E. Rd., Sec. 3, Taipei, 104, Taiwan
Phone: +886-2-2502-5003 Fax: +886-2-2505-1280
<http://www.yaskawa.com.tw>

YASKAWA INDIA PRIVATE LIMITED

#17/A, Electronics City, Hosur Road, Bangalore, 560 100 (Karnataka), India
Phone: +91-80-4244-1900 Fax: +91-80-4244-1901
<http://www.yaskawaindia.in>

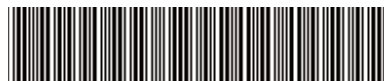
YASKAWA

YASKAWA ELECTRIC CORPORATION

In the event that the end user of this product is to be the military and said product is to be employed in any weapons systems or the manufacture thereof, the export will fall under the relevant regulations as stipulated in the Foreign Exchange and Foreign Trade Regulations. Therefore, be sure to follow all procedures and submit all relevant documentation according to any and all rules, regulations and laws that may apply.

Specifications are subject to change without notice for ongoing product modifications and improvements.

© 2014-2019 YASKAWA ELECTRIC CORPORATION



TOEPC71063611

MANUAL NO. TOEP C710636 11E <4>-YAI

Published in Japan March 2024

16-4-16_YAI

Original instructions