

COOLING FAN

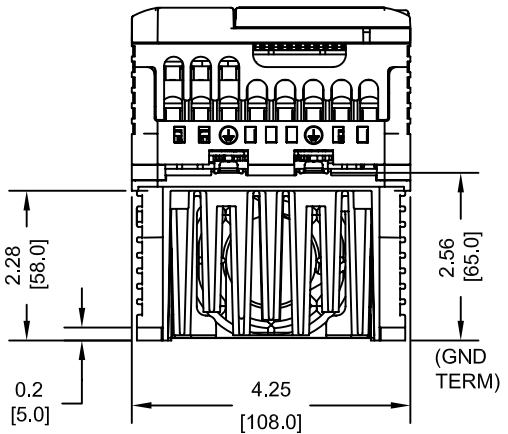
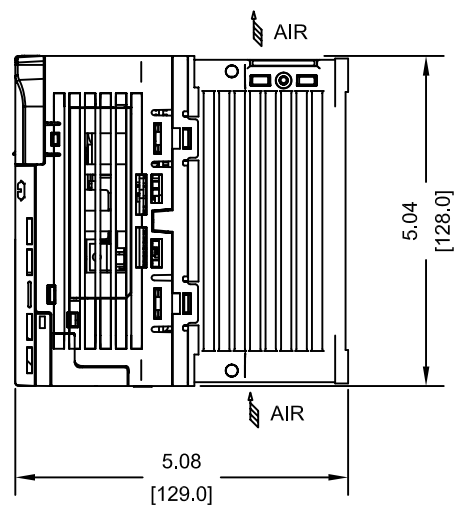
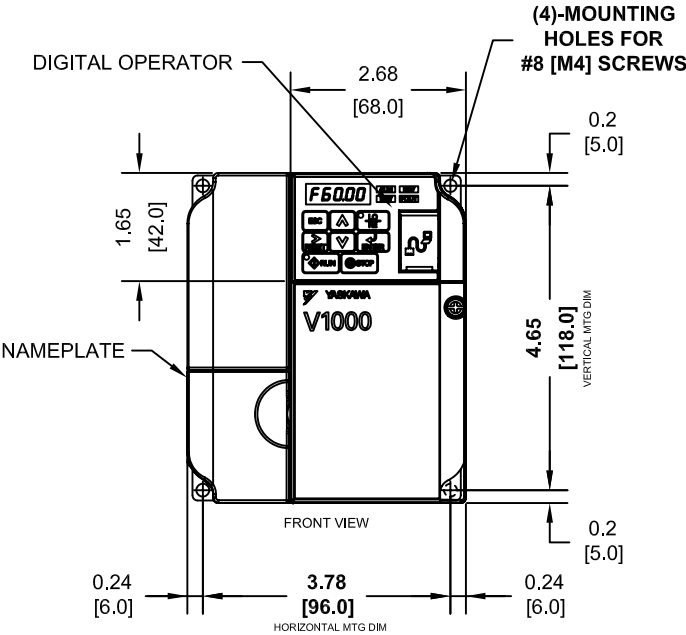
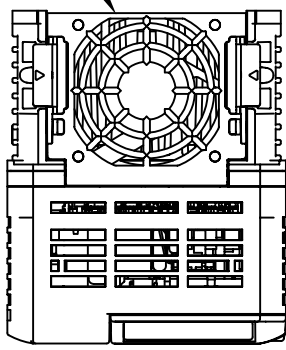

MODEL # CIMR-VU	VOLTAGE THREE PHASE (VAC)	OUTPUT CURRENT (A)		WEIGHT LBS (Kg)	HEAT LOSS (W)					
		ND	HD		ND (Fc=2kHz)			HD (Fc=8kHz)		
					INT	EXT	TOT	INT	EXT	TOT
2A0010BXX	208/240	9.6	8.0	3.7 (1.7)	25.8	51.7	77.5	23.8	54.8	78.6

NOTE:
XX DENOTES AA-ZZ

INT=INTERNAL COMPONENTS
EXT=EXTERNAL HEATSINK
TOT=TOTAL

FOR ADDITIONAL DETAILS AND SPECIFICATIONS, CONSULT MANUAL

TOLERANCES / REFERENCES:		<p>YASKAWA The Drive for Quality™</p> <p><i>THIS DOCUMENT AND INFORMATION CONTAINED IN IT ARE CONFIDENTIAL, AND CANNOT BE COPIED OR DISCLOSED IN WHOLE OR IN PART WITHOUT THE EXPRESS WRITTEN CONSENT OF YASKAWA ELECTRIC AMERICA INC.</i></p>	DRAWN: J. MATTAS CHECKED: J. PIOTROWSKI TECH: J. CAIRO APPROVED: T. SASADA ORIGINAL DESIGN: -	DATE 1-22-09 DATE 8-21-09 DATE 8-24-09 DATE 8-28-09 DATE -	TITLE: V1000 DIMENSION DRAWING FRAME SIZE 7 OPEN ENCLOSURE (IP20 RATING) 2A0010B
UNITS: IN [mm]	SCALE: 1:3		SIZE A	REVISION R00	PAGE 1 of 3
			DRAWING #: DD.V1K.FR7.IP20		

TERMINAL AND WIRING DETAILS (SCALE 1:2)

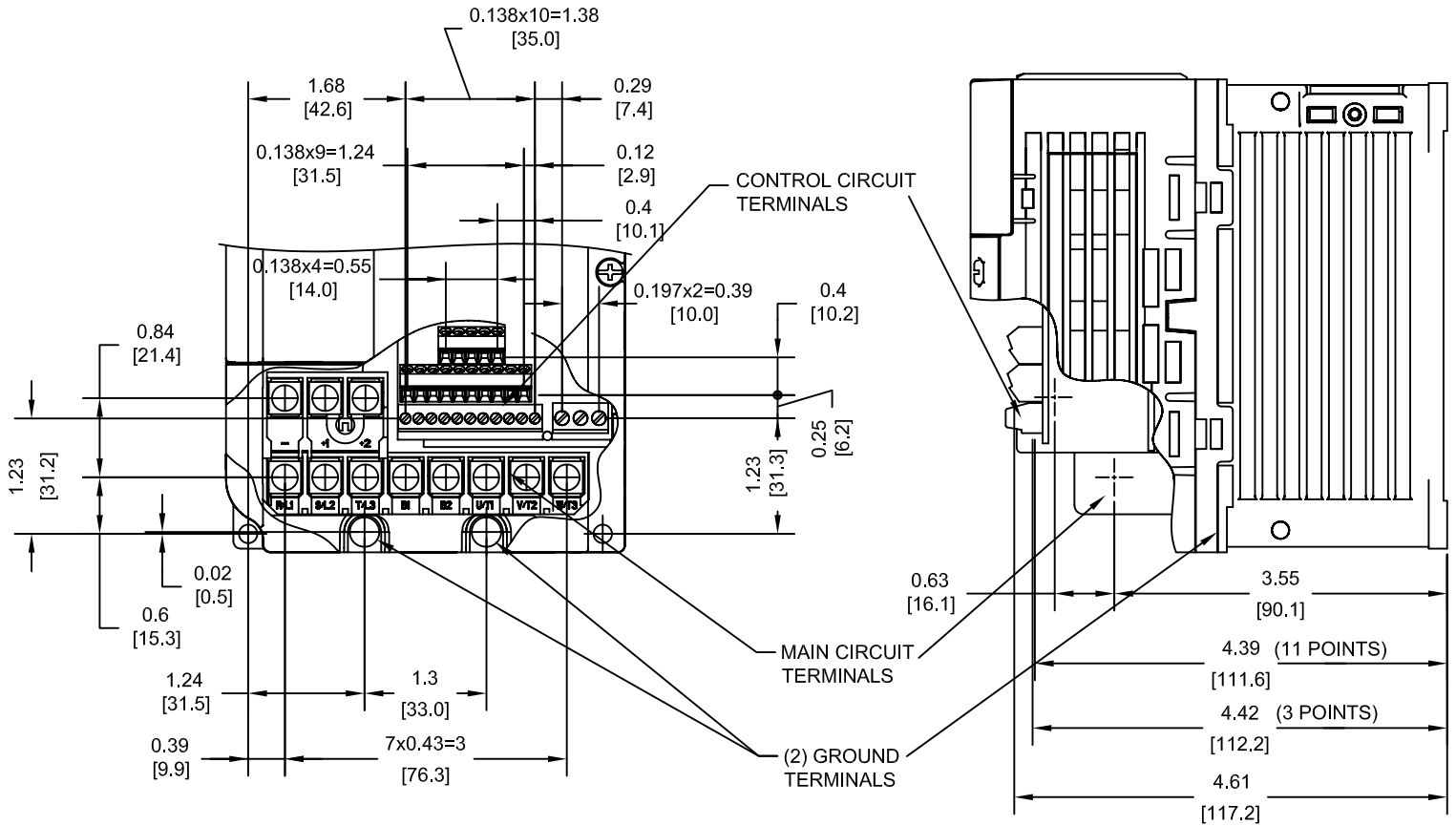

TERMINAL AND WIRE SPECIFICATIONS FOR
MAIN CIRCUIT AND GROUND

MODEL #	TERMINAL SCREW	CLAMPING TORQUE lb.in.(N.m.)	WIRE RANGE AWG(mm ²)
CIMR-VU	M4	10.6 TO 13.3 (1.2 TO 1.5)	22-10 (0.33-5.5)

NOTE: RATINGS APPLY TO BOTH FACTORY AND FIELD WIRING
REFER TO APPLICABLE CODES FOR PROPER WIRE TYPE AND SIZE

FOR ADDITIONAL DETAILS AND SPECIFICATIONS, CONSULT MANUAL

TOLERANCES / REFERENCES:		<p>THIS DOCUMENT AND INFORMATION CONTAINED IN IT ARE CONFIDENTIAL, AND CANNOT BE COPIED OR DISCLOSED IN WHOLE OR IN PART WITHOUT THE EXPRESS WRITTEN CONSENT OF YASKAWA ELECTRIC AMERICA INC.</p>	DRAWN: J. MATTAS DATE 1-22-09	TITLE: V1000 DIMENSION DRAWING FRAME SIZE 7 OPEN ENCLOSURE (IP20 RATING) 2A0010B		
UNITS: IN [mm]			CHECKED: J. PIOTROWSKI DATE 8-21-09	TECH: J. CAIRO DATE 8-24-09	SIZE A	REVISION R00
SCALE: BY VIEW			APPROVED: T. SASADA DATE 8-28-09	ORIGINAL DESIGN: - DATE -	PAGE 2 of 3	DRAWING #: DD.V1K.FR7.IP20

MINIMUM INSTALLATION CLEARANCES (SCALE 1:4)

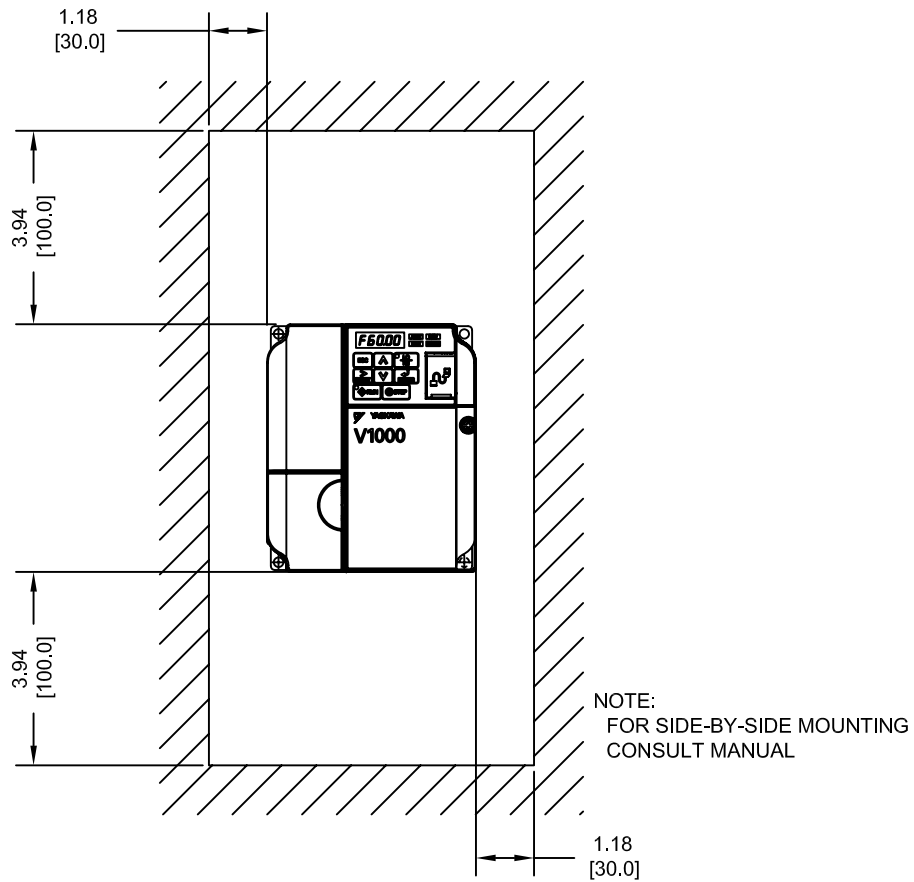

PANEL CUTOUT FOR EXTERNAL HEATSINK MOUNTING CONFIGURATION (SCALE 1:4)

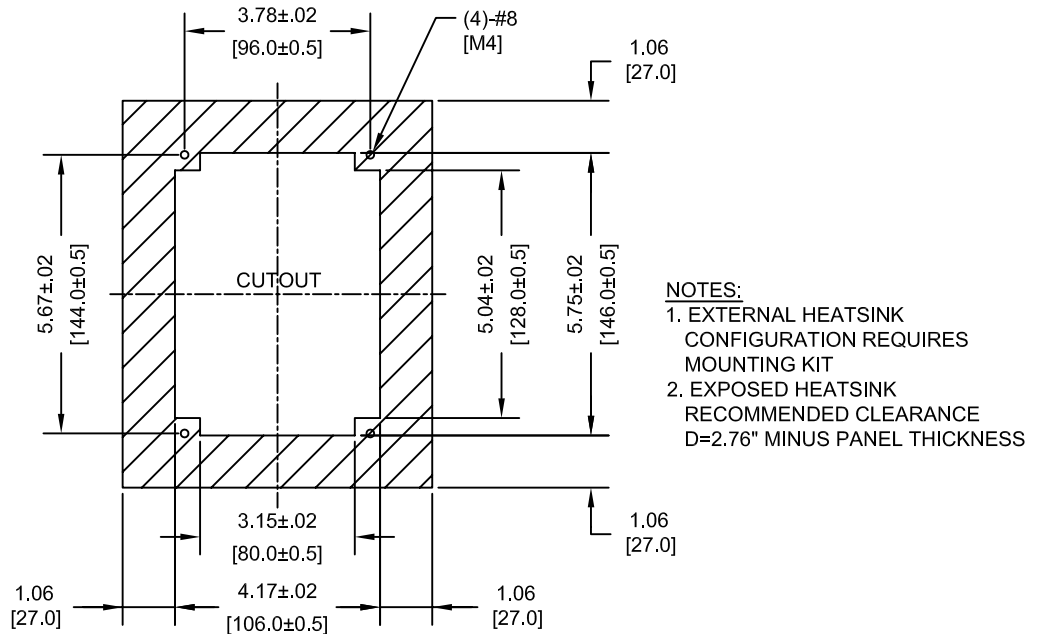

TOLERANCES / REFERENCES:		<p>YASKAWA The Drive for Quality™</p> <p>THIS DOCUMENT AND INFORMATION CONTAINED IN IT ARE CONFIDENTIAL, AND CANNOT BE COPIED OR DISCLOSED IN WHOLE OR IN PART WITHOUT THE EXPRESS WRITTEN CONSENT OF YASKAWA ELECTRIC AMERICA INC.</p>	DRAWN: J. MATTAS DATE: 1-22-09	DATE: 1-22-09	TITLE: V1000 DIMENSION DRAWING FRAME SIZE 7 OPEN ENCLOSURE (IP20 RATING) 2A0010B	
			CHECKED: J. PIOTROWSKI DATE: 8-21-09	DATE: 8-21-09		
			TECH: J. CAIRO DATE: 8-24-09	DATE: 8-24-09		
			APPROVED: T. SASADA DATE: 8-28-09	DATE: 8-28-09		
UNITS: IN [mm]	SCALE: BY VIEW	ORIGINAL DESIGN: -	DATE: -	SIZE: A	REVISION: R00	PAGE: 3 of 3
			DRAWING #:		DD.V1K.FR7.IP20	