

- NOTES:**
- CONNECTED TO THE CABINET. CUSTOMER TO CONNECT THE CABINET GROUND LUGS TO EARTH GROUND AND UTILITY GROUND.
  - CONDUIT FITTINGS/HUBS SHALL COMPLY WITH THE 'STANDARD FOR CONDUIT, TUBING, AND CABLE FITTINGS, UL 514B', OR CONDUIT FITTINGS HAVING THE SAME ENVIRONMENTAL RATING AS THE ENCLOSURE SHALL BE USED.
  - SEE THE TECHNICAL MANUAL FOR USE AND PROGRAMMING OF ADDITIONAL DRIVE LOGIC AND ANALOG INPUTS AND OUTPUTS.
  - BRANCH CIRCUIT PROTECTION TO BE SUPPLIED BY THE CUSTOMER WHEN NOTED ON THE CABINET DATA NAMEPLATE.
  - INSULATED TWISTED SHIELDED WIRE IS REQUIRED. SHIELD TO CONNECT TO PROPER TERMINALS AS SHOWN. CONNECT THE SHIELD ONLY AT THIS END. STUB AND ISOLATE THE OTHER END. DO NOT RUN THESE WIRES IN THE SAME CONDUIT AS THE AC POWER AND AC CONTROL WIRES. KEEP ALL WIRING UNDER 50m IN LENGTH.
  - CUSTOMER TO ADJUST THE THERMOSTAT ON THE SPACE HEATER HR1 FOR MINIMUM DESIRED TEMPERATURE INSIDE THE DRIVE CABINET. THIS SET TEMPERATURE IS NORMALLY SELECTED TO BE SLIGHTLY HIGHER THAN THE MINIMUM AMBIENT TEMPERATURE OF THE AIR SURROUNDING THE CABINET, AND IS THE TEMPERATURE AT WHICH THE SPACE HEATER HR1 WILL SHUT OFF.
  - FOR A CONTROL TRANSFORMER T1 POWER RATING OF 350VA OR GREATER, SECONDARY FUSE F6 IS ADDED.
  - IF AC MOTOR IS FURNISHED WITH A N.C. THERMAL SWITCH THEN SET DRIVE PARAMETER H1-07 TO 27. THIS WILL CAUSE THE DRIVE TO COAST TO STOP UPON AN AC MOTOR THERMAL FAULT. ALONG WITH THIS, ADD THE FOLLOWING CUSTOMER WIRING: WIRE THE N.C. THERMAL SWITCH BETWEEN TERMINALS TB1:7 AND TB1:8.
  - OPTIONS TD, TG, TH, OR TQ CONTROL (SEE UDE00557 FOR MORE INFORMATION)
  - CUSTOMER TO REPLACE THE JUMPER WITH NORMALLY CLOSED SAFETY INTERLOCKS, IF APPLICABLE.
- \* - INDICATES COMPONENTS NOT SUPPLIED BY YASKAWA.  
 --- INDICATES CUSTOMER WIRING.  
 SEE DRAWING UDE00556 FOR CUSTOMER CONNECTION TABLES.  
 SEE DRAWING UDE00557 FOR DRIVE PARAMETER SETTINGS.

REVISIONS				
REV.	DESCRIPTION	ECO #	DRAWN BY	DATE
04	CHANGED OPT. PZ DETAIL & WIRE NO. TO SN	9636	EAA	06/05/19
03	UPDATE TOTAL FANS TO B13	9281	EAA	02/12/19
02	ADD NOTE ON H1-03 SETTING WITH OPT. PZ	8713	EAA	06/01/18

<b>YASKAWA</b>	DRAWN BY: E. ACKERMAN	DATE: 05/01/17	TITLE: SCHEMATIC DIAGRAM IQPUMP1000 CONFIGURED W/ SPBC, TYPE 3R
	CHECKED: N. LAWS	DATE: 09/11/17	
	APPROVED: K. FLIERL	DATE: 10/30/17	SIZE: D
	ORIGINAL DESIG: E. ACKERMAN	DATE: 05/01/17	REVISION: 04
			PAGE: 1 of 3

THIS DOCUMENT AND INFORMATION CONTAINED IN IT ARE CONFIDENTIAL, AND CANNOT BE COPIED OR DISCLOSED IN WHOLE OR IN PART WITHOUT THE EXPRESS WRITTEN CONSENT OF YASKAWA AMERICA INC.

DS.Q1C3R.SPBC.02

INPUT VOLTS	TERMINALS		JUMPER LOCATION
	A	B	
230/240	(H1)	(H4)	(H1) TO (H3) (H2) TO (H4)
460/480	(H1)	(H4)	(H2) TO (H3)

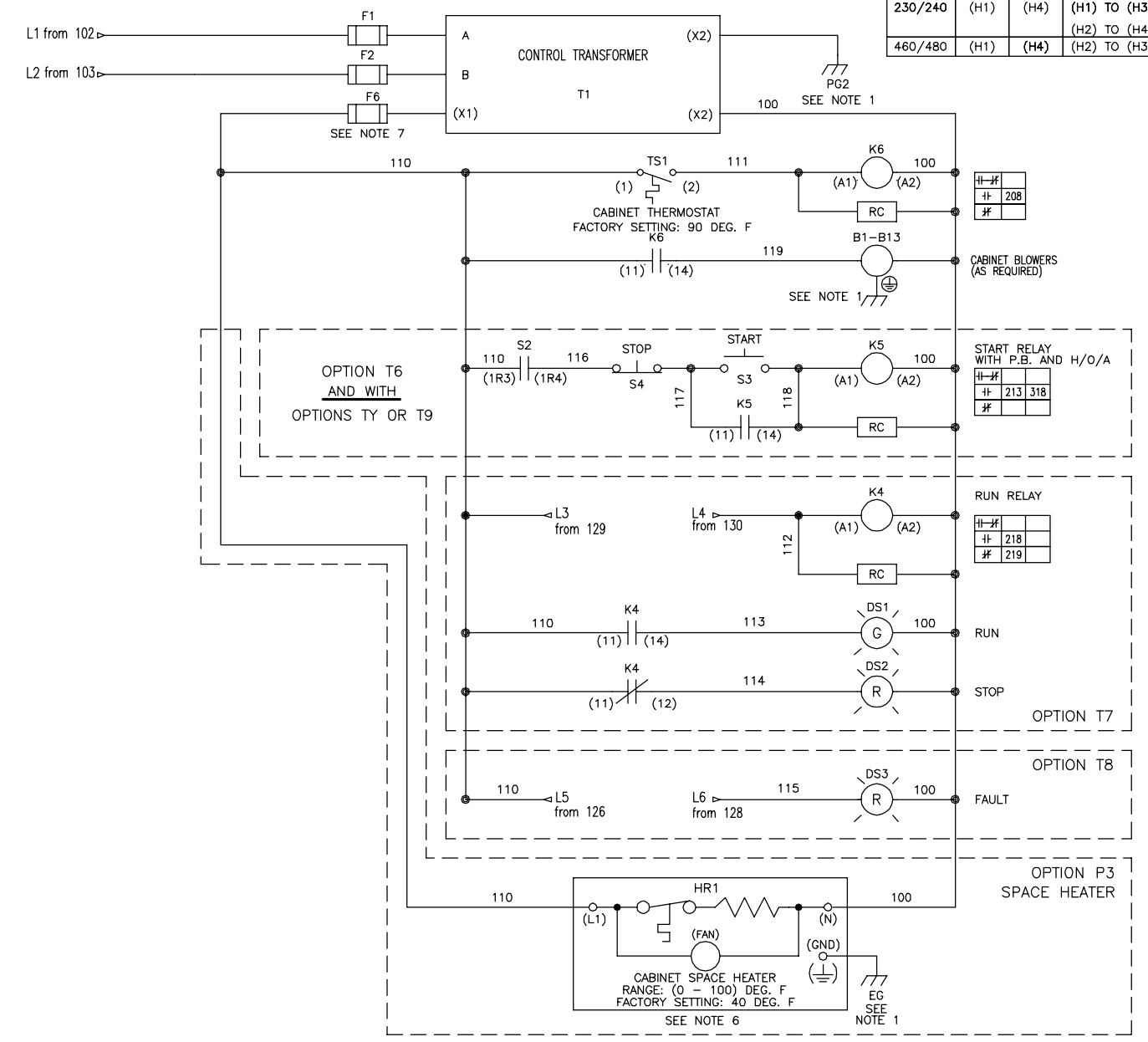

<b>YASKAWA</b>	DRAWN BY: E. ACKERMAN	DATE: 05/01/17	TITLE: SCHEMATIC DIAGRAM
	CHECKED: N. LAWS	DATE: 09/11/17	IQPUMP1000 CONFIGURED W/ SPBC, TYPE 3R
APPROVED: K. FLIERL		DATE: 10/30/17	SIZE: D
E. ACKERMAN		DATE: 05/01/17	REVISION: 04
PAGE: 2 of 3			DRAWING #: DS.Q1C3R.SPBC.02

THIS DOCUMENT AND INFORMATION CONTAINED HEREIN IS CONFIDENTIAL AND NOT BE LOANED, REPRODUCED, COPIED OR DISCLOSED IN WHOLE OR IN PART WITHOUT THE EXPRESS WRITTEN CONSENT OF YASKAWA AMERICA INC.

RUN/STOP CONTROL (FROM SHEET 1)

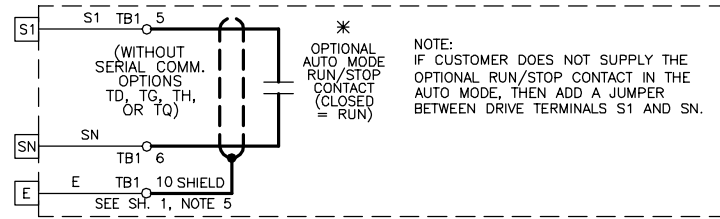

OR

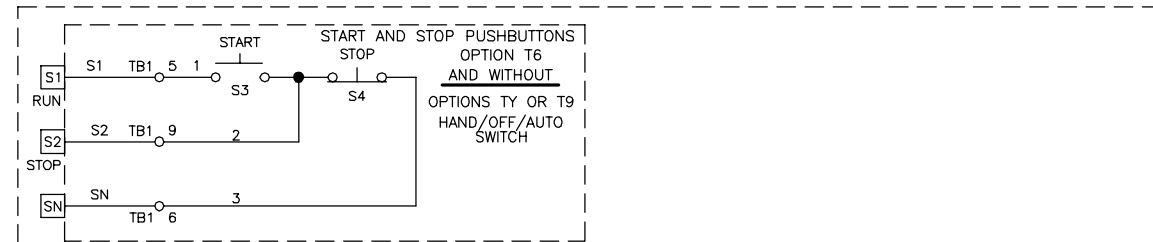

OR

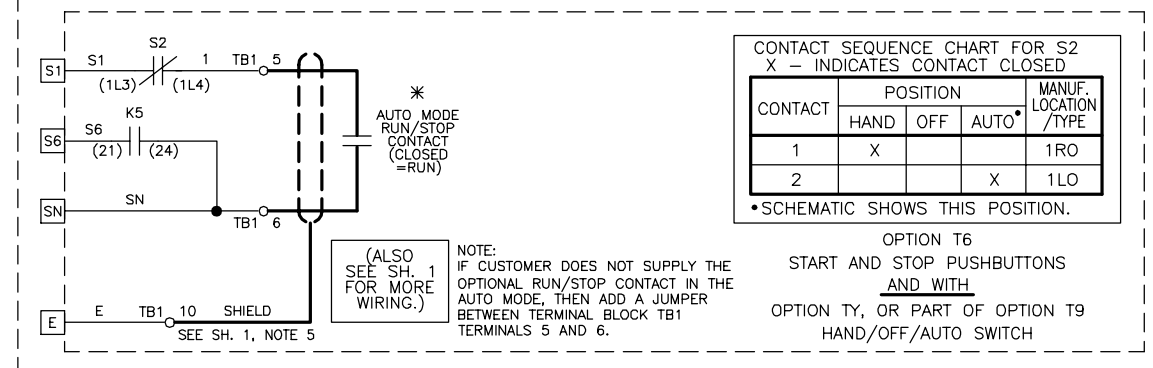

OR

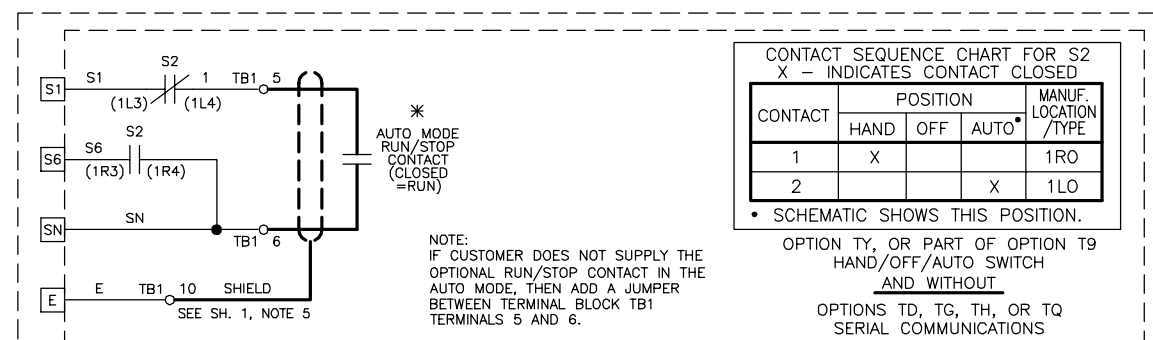

OR

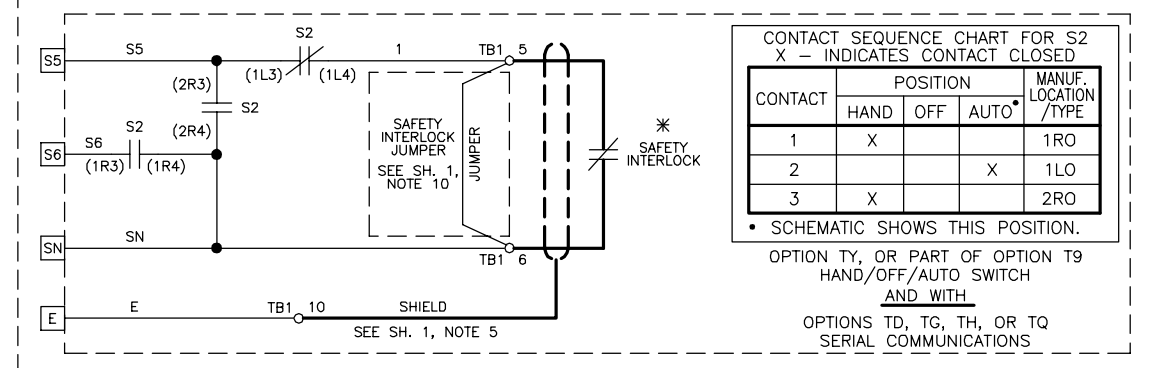

OR

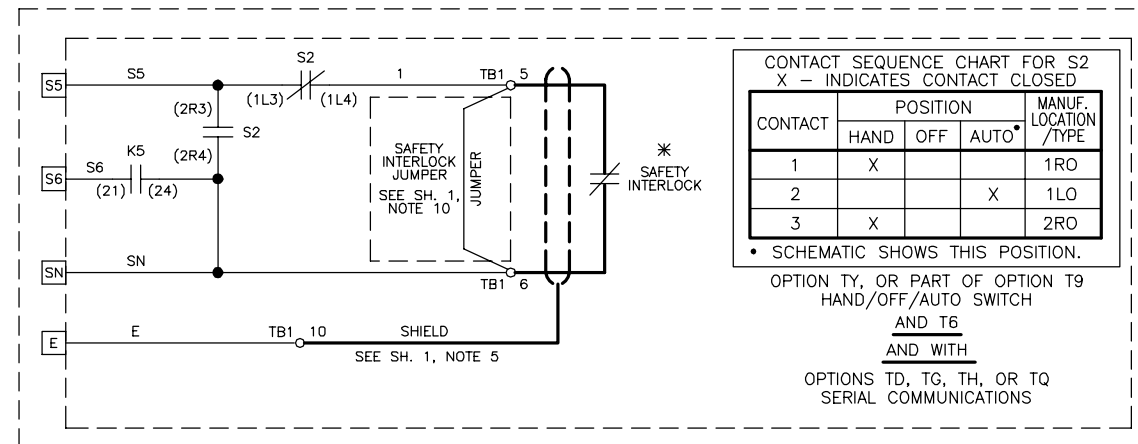

**YASKAWA**

THIS DOCUMENT AND INFORMATION CONTAINED IN IT ARE CONFIDENTIAL, AND CANNOT BE COPIED OR DISCLOSED IN WHOLE OR IN PART WITHOUT THE EXPRESS WRITTEN CONSENT OF YASKAWA AMERICA INC.

DRAWN BY:	E. ACKERMAN	DATE:	05/01/17	TITLE:	SCHEMATIC DIAGRAM IQPUMP1000 CONFIGURED W/ SPBC, TYPE 3R		
CHECKED:	N. LAWS	DATE:	09/11/17	SIZE:	D	REVISION:	04
TECH:		DATE:		ORIGINAL DESIGN:		DATE:	
APPROVED:	K. FLIERL	DATE:	10/30/17	DRAWING #:			
	E. ACKERMAN	DATE:	05/01/17				

DS.Q1C3R.SPBC.02