

ACサーボパック
Σ-IIシリーズ
取扱説明書
MECHATROLINKインタフェースモジュール

形式：JUSP-NS100
対象サーボパック形式：SGDH-□□□E-□

製品を安全にお使い頂くために、本書を必ずお読みください。
また、本書をお手元に保管していただくとともに、最終的に本製品をご使用になるユーザー様のお手元に確実に届けられるよう、お取り計らい願います。

AC SERVOPACK
Σ-II Series
INSTRUCTIONS
MECHATROLINK Interface Module

Model: JUSP-NS100
Applicable SERVOPACK Model: SGDH-□□□E-□

To properly use the product, read this manual thoroughly and retain for easy reference, inspection, and maintenance. Ensure the end user receives this manual.

Copyright © 2001 株式会社 安川電機 YASKAWA ELECTRIC CORPORATION

本書の内容の一部または全部を、当社の文書による許可なしに、転載または複製することは、固くお断りします。

All rights reserved. No part of this publication may be reproduced, stored in a retrieval system, or transmitted, in any form, or by any means, mechanical, electronic, photocopying, recording, or otherwise, without the prior written permission of Yaskawa. No patent liability is assumed with respect to the use of the information contained herein. Moreover, because Yaskawa is constantly striving to improve its high-quality products, the information contained in this manual is subject to change without notice. Every precaution has been taken in the preparation of this manual. Nevertheless, Yaskawa assumes no responsibility for errors or omissions. Neither is any liability assumed for damages resulting from the use of the information contained in this publication.

はじめに

■ 本書の構成

この取扱説明書は、日本語編と英語編で構成しています。

- 日本語編： J-1 ページ～J-25 ページに掲載
- 英語編： E-1 ページ～E-25 ページに掲載

必要に応じて、ご活用ください。

■ 本書の対象読者

本書は下記の方々を対象読者としています。

- Σ -II シリーズ サーボパックの到着時の点検を行う方
- Σ -II シリーズ サーボパックの盤組み込みや配線を行う方
- Σ -II シリーズ サーボパックの操作や運転を行う方
- Σ -II シリーズ サーボパックの保守や点検を行う方

INTRODUCTION

■ Manual Contents

This manual consists of Japanese Version and English Version.

- Japanese Version: Described on pages J-1 to J-25.
- English Version: Described on pages E-1 to E-25.

Use the Japanese Version or English Version as needed.

■ User Instructions

Use these instructions for the following jobs:

- Checking Σ -II Series SERVOPACK on delivery
- Installing Σ -II Series SERVOPACK
- Wiring Σ -II Series SERVOPACK
- Operating Σ -II Series SERVOPACK
- Inspecting and maintenance of Σ -II Series SERVOPACK

CONTENTS

Σ-II Series	
MECHATROLINK Interface Module	E-1
SYMBOLS FOR SAFE OPERATION	E-4
NOTES FOR SAFE OPERATION	E-4
1 PARTS	E-8
2 CHECKING ON DELIVERY	E-9
2.1 Checking Items	E-10
2.2 Appearance and Nameplate	E-10
2.3 Type Designation	E-11
2.4 Mounting NS100 Module	E-11
3 INSTALLATION	E-14
3.1 Storage	E-14
3.2 Installation Sites	E-15
3.3 Orientation	E-15
3.4 Installation Precautions	E-16
4 WIRING	E-17
4.1 MECHATROLINK Connection Example	E-18
4.2 Precautions on Wiring	E-19
5 OPERATION	E-20
5.1 Precautions at Test Run	E-20
5.2 Precautions at Operation	E-21
6 INSPECTION AND MAINTENANCE	E-22
7 MEASURES TO SATISFY THE EMC DIRECTIVE	E-23
7.1 MECHATROLINK Communication Cable	E-23
7.2 Fully Closed Encoder Cable	E-23
7.3 The Core on the Cable	E-23
7.4 Cable Clamp	E-24
7.5 Wiring Examples	E-25

INSTRUCTIONS

Σ-II Series MECHATROLINK Interface Module

Σ-II Series MECHATROLINK Interface Module	E-1
SYMBOLS FOR SAFE OPERATION	E-4
NOTES FOR SAFE OPERATION	E-4
1 PARTS	E-8
2 CHECKING ON DELIVERY	E-9
2.1 Checking Items	E-10
2.2 Appearance and Nameplate	E-10
2.3 Type Designation	E-11
2.4 Mounting NS100 Module	E-11
3 INSTALLATION	E-14
3.1 Storage	E-14
3.2 Installation Sites	E-15
3.3 Orientation	E-15
3.4 Installation Precautions	E-16
4 WIRING	E-17
4.1 MECHATROLINK Connection Example	E-18
4.2 Precautions on Wiring	E-19
5 OPERATION	E-20
5.1 Precautions at Test Run	E-20
5.2 Precautions at Operation	E-21
6 INSPECTION AND MAINTENANCE	E-22

7	MEASURES TO SATISFY THE EMC DIRECTIVE	E-23
7.1	MECHATROLINK Communication Cable	E-23
7.2	Fully Closed Encoder Cable	E-23
7.3	The Core on the Cable	E-23
7.4	Cable Clamp	E-24
7.5	Wiring Examples	E-25

This instruction manual covers Σ -II series SGD_H MECHATROLINK Interface Module (hereinafter called NS100 Module), which is an application module to be connected to Σ -II series SGD_H SERVOPACK for MECHATROLINK.

To properly use the application module, read this manual thoroughly and retain for easy reference for inspections and maintenance etc.

Reference materials are listed below:

Manual Titles	manual No.
Σ -II series SGM□H/SGD _H User's Manual Servo Selection and Data Sheets	SIE-S800-32.1
Σ -II series SGM□H/SGD _H User's Manual Design and Maintenance	SIE-S800-32.2
Σ -II series SGD _H MECHATROLINK Interface Module User's Manual	SIE-C718-4
AC SERVOMOTOR INSTRUCTIONS	TOE-C231-2
Σ -II series SGD _H Instruction Manual	TOB-S800-32

SYMBOLS FOR SAFE OPERATION

In this manual, the NOTES FOR SAFE OPERATION are classified as “WARNING” or “CAUTION”. The following symbols are used.



Indicates a potentially hazardous situation which, if not avoided, could result in death or serious personal injury.



Indicates a potentially hazardous situation which, if not avoided, may result in minor or moderate personal injury and/or damage to the equipment.

In some instances, items described in  may also result in a serious accident. In either case, follow these important items.

NOTES FOR SAFE OPERATION

Read this manual thoroughly before installation, operation, maintenance or inspection of the AC Servo Drives.

■ CHECKING ON DELIVERY

 WARNING	
<ul style="list-style-type: none">Do not apply or use the NS100 Module in conjunction with SGD_H SERVOPACK version 12. <p>There is a potential for an unintended servomotor brake release with the NS100 Module in connection with the SGD_H SERVOPACK version 12 and in connection with Σ-II motors with holding brakes.</p> <p>AN UNINTENDED RELEASE COULD RESULT IN INJURY TO PERSONS OR EQUIPMENT IN CLOSE PROXIMITY TO ANY MECHINERY CONTROLLED BY THE SERVO SYSTEM.</p> <p>IN CLOSE PROXIMITY TO ANY MACHINERY CONTROLLED BY THE SERVO SYSTEM.</p> <p>In this product combination the motor holding brake will release 3 seconds after power is supplied to the SGD_H SERVOPACK even though the SERVOPACK is disabled (SERVO ON signal is OFF).</p>	<p>(Ref.No.) E-9</p>

CAUTION

(Ref.No.)

- There is a limitation in the combination of the software version of the SGDH SERVOPACK and the software version of the NS100 Module.
When the software version of the SGDH SERVOPACK is 11 or lower: Applicable to all the versions of the NS100
When the software version of the SGDH SERVOPACK is 12 or higher: Applicable to version 7 or higher of the NS100
When the wrong combination is used, an alarm A.BF SYSTEM ERROR (operation error) may occur.
- When SGDH SERVOPACK is used with a NS100 Module mounted, the parameters are automatically set so that the NS100 Module can be operated from the first power ON.
For details of parameter setting methods, refer to Σ -II Series SGM□/SGDH User's Manual Desine and Maintenance (SIE-S800-32.2).

E-9

E-10

■ INSTALLATION

CAUTION

(Ref.No.)

- Never use the equipment where it may be exposed to splashes of water, corrosive or flammable gases, or near flammable materials.
Failure to observe this caution may result in electric shock or fire.

E-14

■ WIRING

WARNING

(Ref.No.)

- SERVOPACK grounding must be in accordance with the national code and consistent with sound local practices.
Failure to observe this warning may result in electric shock or fire.

E-17

CAUTION

(Ref.No.)

- Do not connect three-phase power supply to SERVOPACK output terminals U, V, and W.
Failure to observe this caution may lead to personal injury or fire.
- Securely tighten screws on the power supply and motor output terminals.
Failure to observe this caution may result in a fire.

E-17

E-17

■ OPERATION

 CAUTION	
<ul style="list-style-type: none"> • To avoid inadvertent accidents, run the servomotor only in test run (without load). <p>Failure to observe this caution may result in personal injury.</p>	(Ref.No.) E-20
<ul style="list-style-type: none"> • Before starting operation with a load connected, set up parameters suitable for the machine. <p>Starting operation without setting up parameters may result in machine overrun or failure.</p>	E-20
<ul style="list-style-type: none"> • Before starting operation with a load connected, make sure emergency-stop procedures are in place. <p>Failure to observe this caution may result in personal injury.</p>	E-20
<ul style="list-style-type: none"> • During operation, do not touch the SERVOPACK'S heatsink. <p>Failure to observe this caution may result in burns.</p>	E-21

■ INSPECTION AND MAINTENANCE

 WARNING	
<ul style="list-style-type: none"> • Never touch the inside of the SERVOPACKs. <p>Failure to observe this warning may result in electric shock.</p>	(Ref.No.) E-22
<ul style="list-style-type: none"> • Never open the terminal cover while power is ON, and never turn ON power when the terminal cover is open. <p>Failure to observe this warning may result in electric shock.</p>	E-22
<ul style="list-style-type: none"> • After turning OFF power, wait at least five minutes before servicing the product. <p>Otherwise, residual electric charges may result in electric shock.</p>	E-22

 CAUTION	
<ul style="list-style-type: none"> • Never change wiring while power is ON. <p>Failure to observe this caution may result in electric shock or personal injury.</p>	(Ref.No.) E-22

■ General Precautions

Note the following to ensure safe application.

- Some drawings in this manual are shown with the protective cover or shields removed, in order to describe the detail with more clarity. Make sure all covers and shields are replaced before operating this product.
- Some drawings in this manual are shown as typical example and may differ from the shipped product.
- This manual may be modified when necessary because of improvement of the product, modification or changes in specifications.
Such modification is made as a revision by renewing the manual No.
- To order a copy of this manual, if your copy has been damaged or lost, contact your YASKAWA representative listed on the last page stating the manual No. on the front cover.
- YASKAWA is not responsible for accidents or damages due to any modification of the product made by the user since that will void our guarantee.

WARNING LABEL

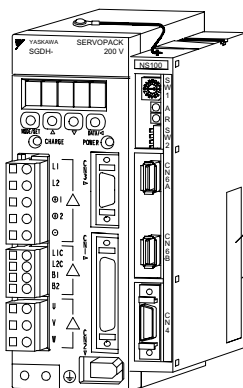
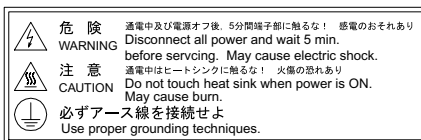

SERVOPACK warning label position

SERVOPACK Warning Label and Grounding Mark Position

1 PARTS

The NS100 Module parts names are as follows:

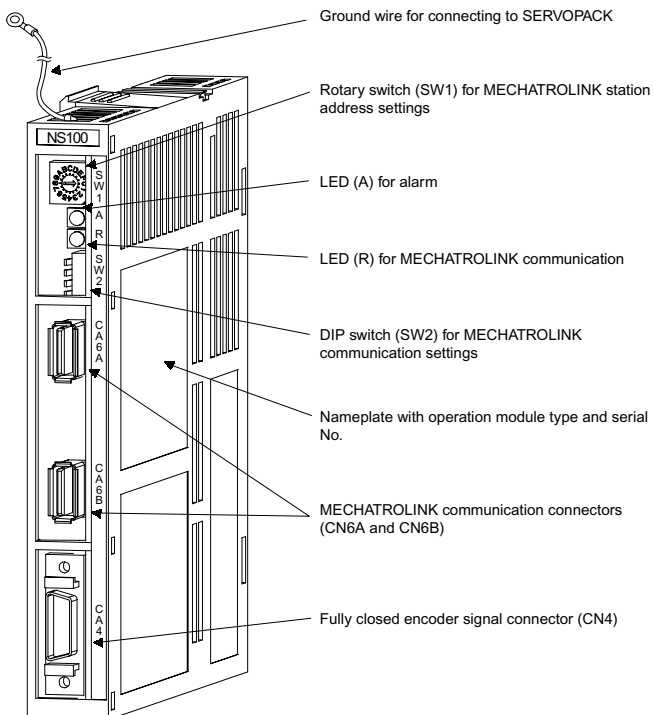

2 CHECKING ON DELIVERY

WARNING

- Do not apply or use the NS100 Module in conjunction with the SGDH NS100 SERVOPACK version 12.

There is a potential for an unintended servomotor brake release with the NS100 Module in connection with the SGDH SERVOPACK version 12 and in connection with Σ -II motors with holding brakes. AN UNINTENDED RELEASE COULD RESULT IN INJURY TO PERSONS OR EQUIPMENT IN CLOSE PROXIMITY TO ANY MECHINERY CONTROLLED BY THE SERVO SYSTEM. IN CLOSE PROXIMITY TO ANY MACHINERY CONTROLLED BY THE SERVO SYSTEM. In this product combination the motor holding brake will release 3 seconds after power is supplied to the SGDH SERVOPACK even though the SERVOPACK is disabled (SERVO ON signal is OFF).

Note: The brake release above occurs only when the software version 12 of the SGDH SERVOPACK and any versions of the NS100 Module are used together. It does not occur when only the SGDH SERVOPACK is used or is used with any application modules other than the NS100 Module.

Check the software version of the SGDH SERVOPACK on the front face underneath the model number or in the parameter Fn012.

Version tool:

*** 12

— The lower two digits of the software version

Monitor mode: Fn012.

CAUTION

- There is a limitation in the combination of the software version of the SGDH SERVOPACK and the software version of the NS100 Module.

When the software version of the SGDH SERVOPACK is 11 or lower: Applicable to all the versions of the NS100 Module

When the software version of the SGDH SERVOPACK is 12 or higher: Applicable to version 7 or higher of the NS100 Module

When the wrong combination is used, an alarm A.BF SYSTEM ERROR (operation error) may occur.

Note: Check the software version as follows:

Software version of the SGDH SERVOPACK: Lower two digit of the version tool

*** 12

Software version of the NS100 Module: Lower two digits of the version number in the nameplate

*** 07

⚠ CAUTION

- When SGD_H SERVOPACK is used with a NS100 Module mounted, the parameters are automatically set so that the NS100 Module can be operated from the first power ON.

For details of parameter setting methods, refer to Σ -II Series SGM□/SGD_H User's Manual Design and Maintenance (SIE-S800-32.2).

2.1 Checking Items

When Σ -II Series products are delivered, check the following items:

Check Items	Remarks
Check if the delivered products are the ones you ordered.	Check the types marked on the nameplates of the NS100 Module.
Check if the motor shaft rotates smoothly.	If the motor shaft is smoothly turned by hand, it is normal. However, if the motor has brakes, it cannot be turned manually.
Check for damage.	Check the overall appearance, and check for damage or scratches resulting from transportation.
Check if SERVOPACK is the type applicable for NS100 Module?	Check the nameplate of SERVOPACK. SERVOPACK Type SGD _H -□□□E-□ ① ② “SGD _H ” in ①, and “E” in ②

If any of the above items are faulty or incorrect, contact the dealer from which you purchased the products or your nearest local sales representative.

2.2 Appearance and Nameplate

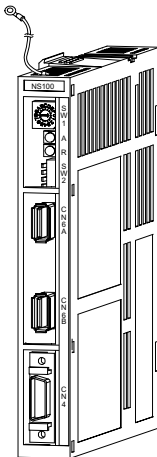

NS100 module

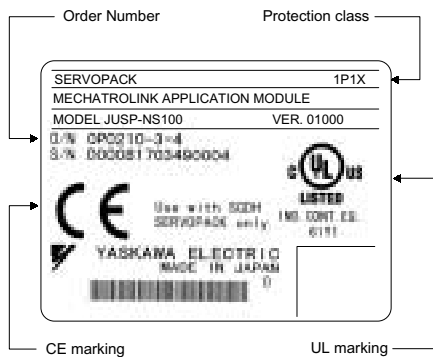

2.3 Type Designation

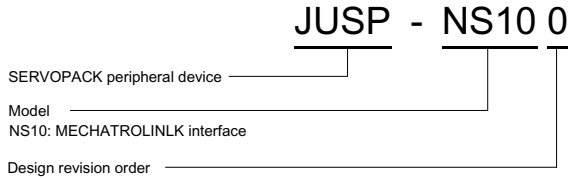

2.4 Mounting NS100 Module

Mount a NS100 Module on a SGDH SERVOPACK in the following manner. Provide the screws for connecting ground wire as shown below.

Mounting Method	SERVOPACK Type	Screw	Remarks
Base mounted	SGDH-A3 to 02BE SGDH-A3 to 10AE	M3×10 round head screws (with spring washer and plain washer)	Attachments.
	SGDH-15 to 50AE SGDH-05 to 50DE	M4×10 round head screws (with spring washer and plain washer)	Attachments.
	SGDH-60 to 1EAE SGDH-60 to 1EDE	M4×8 round head screws (with spring washer and plain washer)	Use the screw of the front panel.
Rack mounted	SGDH-A3 to 02BE-R SGDH-A3 to 50AE-R SGDH-05 to 50DE-R	M4×6 round head screws (with spring washer and plain washer)	Attachments. Note: Make sure that spring washers and plain washers are used for mounting. (Otherwise, the screw for connecting ground wire sticks out from the other side of the flange, and the SERVOPACK cannot be mounted properly.)
Duct ventilated	SGDH-60 to 1EAE-P SGDH-60 to 1EDE-P	M4×8 round head screws (with spring washer and plain washer)	Use the screw of the front panel.

1. Remove the connector cover mounted on CN10 of SERVOPACK.

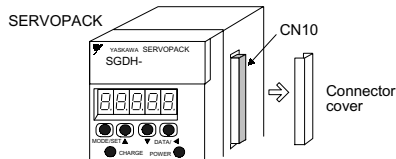

2. Mount a NS100 Module.

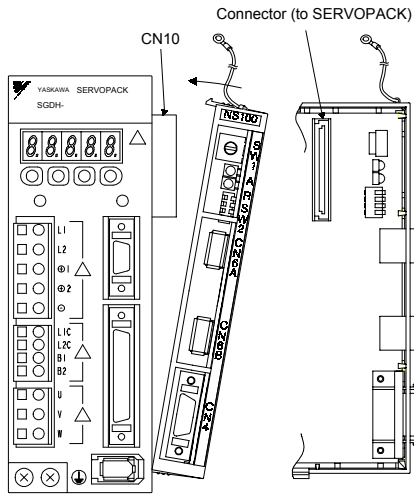

3. For grounding, connect a ground wire of the NS100 Module to the marked “G” on the SERVOPACK.

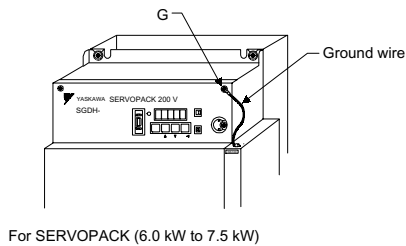
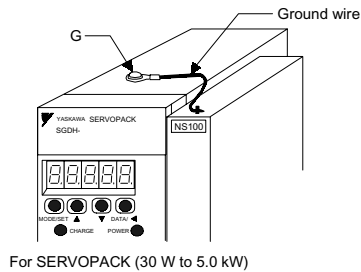

The appearance of SERVOPACK with application module properly mounted is shown below

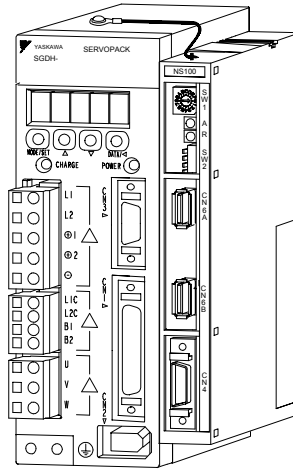

3 INSTALLATION

Σ -II Series SGDH SERVOPACK is a base-mount type servo controller. Incorrect installation will cause problems. Always observe the installation instructions described below.

CAUTION

- Never use the equipment where it may be exposed to splashes of water, corrosive or flammable gases, or near flammable materials.

Failure to observe this caution may lead to electric shock or fire.

3.1 Storage

When the SERVOPACK is to be stored with the power cable disconnected, store it in the following temperature range:

Between -20 to +85°C

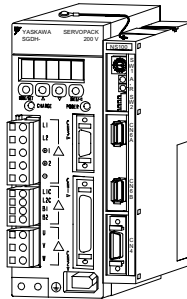

Σ -II Series
SGDH SERVOPACK with NS100 Module Mounted

3.2 Installation Sites

For installation sites, use proper care with the following notes.

Situation	Notes on Installation
When installed in a control panel	Design the control panel size, unit layout, and cooling method so that the temperature around the periphery of the SERVOPACK does not exceed 55°C.
When installed near a heating unit	Suppress radiation heat from the heating unit and a temperature rise caused by convection so that the temperature around the periphery of the SERVOPACK does not exceed 55°C.
When installed near a source of vibration	Install a vibration isolator underneath the SERVOPACK to prevent it from receiving vibration.
When installed in a place receiving corrosive gases	Corrosive gases do not immediately affect the SERVOPACK but will eventually cause contactor-related devices to malfunction. Take appropriate action to protect against corrosive gases.
Others	Avoid installation in a hot and humid place or where excessive dust or iron powder is present in the air. Install in a place where the altitude is 1000 m or less.

3.3 Orientation

Install the SERVOPACK perpendicular to the wall as shown in the figure below.

The SERVOPACK must be orientated as shown in the figure.

Firmly secure the SERVOPACK through two to four mounting holes depending on the SERVOPACK capacity.

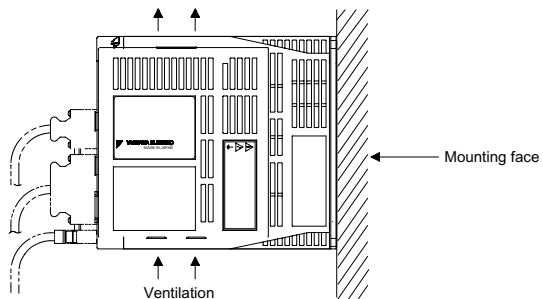

3.4 Installation Precautions

When installing multiple SERVOPACKs side by side in a control panel, observe the following installation method:

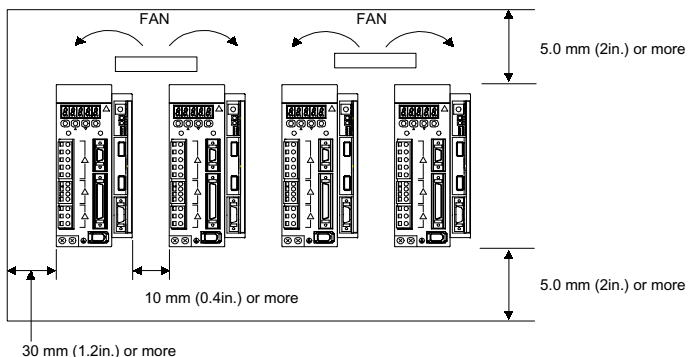

■ Front Panel

Install SERVOPACK perpendicular to the wall so that the front panel (digital operator mounted face) faces outward.

■ Cooling

Provide sufficient space around each SERVOPACK to allow cooling by fan and natural convection.

■ Where mounted side by side

When installing SERVOPACKs side by side, provide at least 10mm (0.4in.) space between them and at least 50mm (2in.) space above and below them as shown in the figure above. Install cooling fans above the SERVOPACKs to prevent the temperature around each SERVOPACK from increasing excessively and also to maintain the temperature inside the control panel evenly.

■ Environments in Control Panel

Maintain the following conditions inside the control panel:

- Ambient temperature for SERVOPACK: 0 to 55°C
- Humidity: 90%RH or less
- Vibration: 4.9 m/s²
- Condensation and freezing: None
- Ambient temperature to ensure long-term reliability: 45°C or less
- Altitude of 1000 m max.

4 WIRING

This section shows a standard example for connecting Σ -II series products to peripheral devices and briefly explains how to connect each peripheral device.

WARNING

- SERVOPACK grounding must be in accordance with the national code and consistent with sound local practices.

Failure to observe this warning may lead to electric shock or fire.

CAUTION

(WIRING)

- Do not connect three-phase power supply to SERVOPACK output terminals U, V and W.

Failure to observe this caution may lead to personal injury or fire.

- Securely tighten screws on the power supply and motor output terminals.

Failure to observe this caution can result in a fire.

For the following wiring, refer to Σ -II series SGM□H/SGDH User's Manual Design and Maintenance (SIE-S800-32.2) and Σ -II series SGDH MECHATROLINK Interface Module User's Manual (SIE-C718-4).

- Main circuit wiring
- I/O signal wiring
- Encoder wiring
- Example of connections

4.1 MECHATROLINK Connection Example

An example of MECHATROLINK connection is shown below.

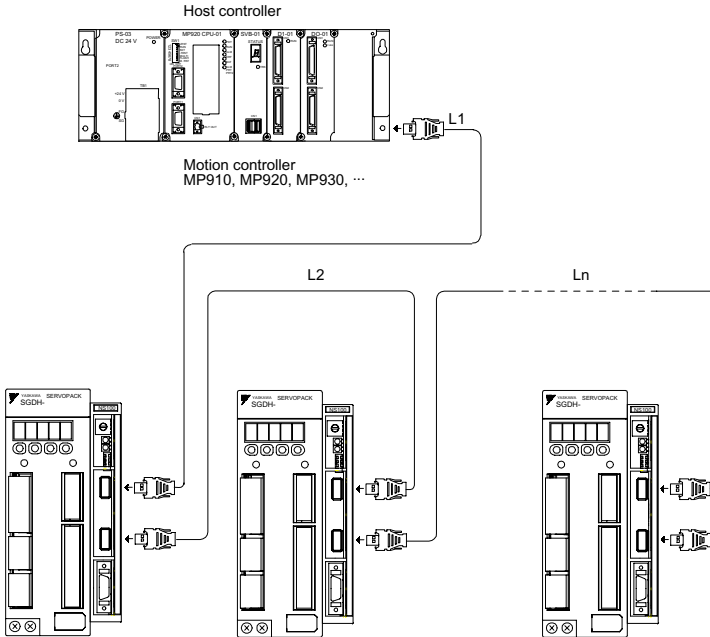

Note: The total length of cable should be “ $L1 + L2 + \dots + Ln \leq 50m$ ”
Up to 15 stations can be connected.

4.2 Precautions on Wiring

Take note the following precautions at wiring.

■ Connectable Maximum Number of Stations

Up to 15 slave stations can be connected.

■ Cables

Use the following cables.

Cable	Type	Length (m)
MECHATROLINK Communication Cable (With connector on both ends)	JEPMC-W6000-A3	0.3
	JEPMC-W6000-A5	0.5
	JEPMC-W6000-01	1.0

For other peripheral devices, refer to Σ -II series SGM□H/SGDH User's Manual Design and Maintenance (SIE-S800-32.2) and Σ -II series SGDH MECHATROLINK Interface Module User's Manual (SIE-C718-4).

■ Total cable length

The total cable length should be 50 m and less.

(Station 1 + Station 2 + ... Station \leq 50 m)

■ Terminator

Be sure to install the following terminator on SERVOPACK of terminal station.

Terminator	Type
MECHATROLINK Communication Terminator	JEPMC-W6020

5 OPERATION

This section provides precautions at test run and operation. For instructions on test run and operation, refer to Σ -II series SGM□H/SGDH User's Manual Design and Maintenance (SIE-S800-32.2) and Σ -II series SGDH MECHATROLINK Interface Module User's Manual (SIE-C718-4).

5.1 Precautions at Test Run

 CAUTION
--

- | |
|---|
| <ul style="list-style-type: none">• To avoid inadvertent accidents, run the servomotor only in test run (without load).
Failure to observe this caution may result in personal injury.• Before starting operation with a load connected, set up parameters suitable for the machine.
Starting operation without setting up parameters may lead to overrun failure.• Before starting operation with a connected load, make sure emergency-stop procedures are in place.
Failure to observe this caution may result in personal injury. |
|---|

■ Conducting Test Run for Servomotor without Load

When servomotor is operated without load, set the load inertia (parameter Pn103) to 0. (Factory setting is 0)

When servomotor is rotated without load (without load inertia), if the value has been set to other than 0, the servomotor may oscillate.

To avoid this, make sure to set the load inertia to 0 and then servo ON.

■ Conducting Test Run with Servomotor Connected to Machine

SERVOPACK initial parameters setting is performed assuming normal operation conditions. Before test run, set up parameters suitable for the machine.

Failure to set up the parameters initial setting may result in machine overrun or breakdown.

As for the setting procedures and methods, refer to Σ -II Series SGM□H/SGDH User's Manual Design and Maintenance (SIE-S800-32.2).

■ Check Item during Test Run

The following items should be checked during test run.

- Unusual vibration
- Abnormal noise
- Excessive temperature rise

5.2 Precautions at Operation

 **CAUTION**

- During operation, do not touch the SERVOPACK'S heatsink.

Failure to observe this caution may result in burns.

6 INSPECTION AND MAINTENANCE

This section describes the basic inspections and maintenance. If any failure occurs on SER-VOPACK, refer to Σ -II Series SGM□H/SGDH User's Manual Design and Maintenance Section 10.2 Troubleshooting (SIE-S800-32.2) and Σ -II Series SGDH MECHATROLINK Interface Module User's Manual (SIE-C718-4). Contact your Yaskawa representative if the problem cannot be solved by the procedures described.

WARNING

- Be sure to turn OFF power before inspection or maintenance.
Otherwise, electric shock may result.
- Never open the terminal cover while power is ON, and never turn ON power when the terminal cover is open.
Otherwise, electric shock may result.
- After turning OFF power, wait at least five minutes before servicing the product.
Otherwise, residual electric charges may result in electric shock.

CAUTION

- Never change wiring while power is ON.
Failure to observe this caution may result in electric shock or personal injury.

7 MEASURES TO SATISFY THE EMC DIRECTIVE

This section describes the measures required for MECHATROLINK Interface Module to conform to EMC Directive (EN50081-2, EN50082-2).

7.1 MECHATROLINK Communication Cable

For serial communication (CN6A, CN6B) connector, use the connector for special use.
Max. cable length is 50 m.
Use the twisted pair shielded cable.

7.2 Fully Closed Encoder Cable

For fully closed encoder (CN4) connector, use the following connector.
Use the twisted pair shielded cable.

Connector: 54306-2011 (Made by Molex Japan Co., Ltd.)

Connector case: 54331-0201 (Made by Molex Japan Co., Ltd.)

7.3 The Core on the Cable

Attach the core on the cable as shown below:

Core Model	ESD-SR-25
Quantity	1
Turn	2
Manufacturer	Tokin.Corp.

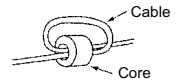

Cable line and the line position where the core are attached are shown below.

Cable Name	Mounting Position of Core
MECHATROLINK Communication Cable	Near the host controller and SERVOPACK side
Fully Closed Encoder Cable	Near the SERVOPACK side

7.4 Cable Clamp

Fix and ground the cable shield using a piece of conductive metal.

<Example of Cable Clamp>

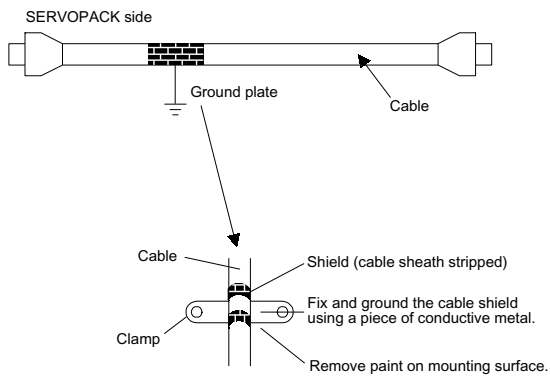

7.5 Wiring Examples

The following diagrams show the wiring example. Before wiring, turn OFF the Power ON/OFF switch and post a notice of “No Conduction”. Only an electrical expert can perform the wiring. The noise filter and the core are shown in the diagram.

<REQUIRED EN SPECIFICATIONS>

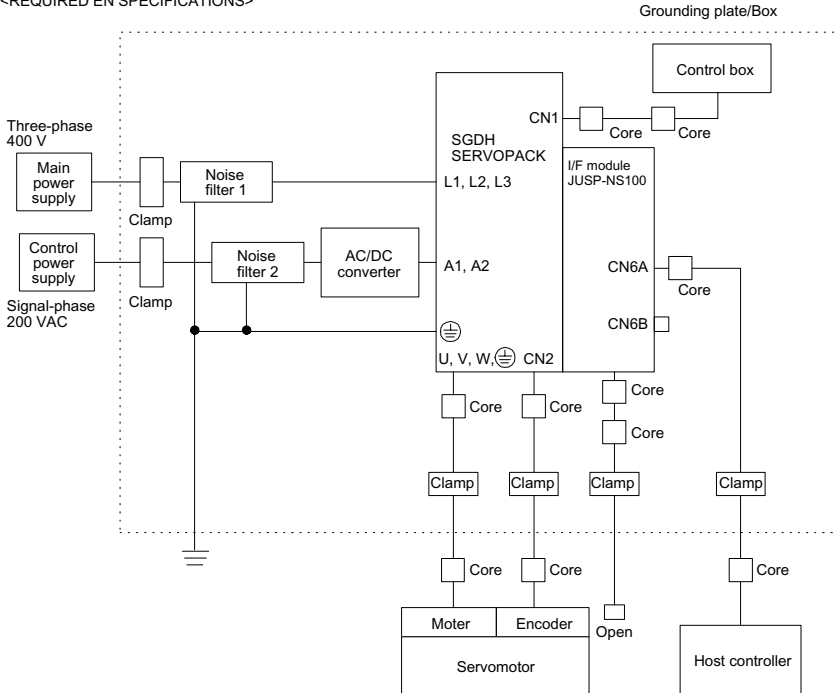

- Note: 1. Clamp: Secure cable shields and ground for conductive metal parts.
 2. Make sure that the grounding plate are securely connected to the grounding.
 3. Remove the paint from the grounding plate to insure a good Earth connection for filter, SERVOPACK, clamp, etc.

AC SERVOPACK Σ -II Series INSTRUCTIONS MECHATROLINK Interface Module

IRUMA BUSINESS CENTER (SOLUTION CENTER)

480, Kamifujisawa, Inuma, Saitama 358-8555, Japan
Phone 81-4-2962-5151 Fax 81-4-2962-6138
<http://www.yaskawa.co.jp>

YASKAWA AMERICA, INC.

2121 Norman Drive South, Waukegan, IL 60085, U.S.A.
Phone 1-800-YASKAWA (927-5292) or 1-847-887-7000 Fax 1-847-887-7310
<http://www.yaskawa.com>

YASKAWA ELÉTRICO DO BRASIL LTDA.

Avenida Piraporinha 777, Diadema, São Paulo, 09950-000, Brasil
Phone 55-11-3585-1100 Fax 55-11-3585-1187
<http://www.yaskawa.com.br>

YASKAWA EUROPE GmbH

Hauptstraße 185, Eschborn 65760, Germany
Phone 49-6196-569-300 Fax 49-6196-569-398
<http://www.yaskawa.eu.com>

YASKAWA ELECTRIC KOREA CORPORATION

9F, Kyobo Securities Bldg, 26-4, Yeouido-dong, Yeongdeungpo-gu, Seoul, 150-737, Korea
Phone 82-2-784-7844 Fax 82-2-784-8495
<http://www.yaskawa.co.kr>

YASKAWA ELECTRIC (SINGAPORE) PTE. LTD.

151 Lorong Chuan, #04-02A, New Tech Park 556741, Singapore
Phone 65-6282-3003 Fax 65-6289-3003
<http://www.yaskawa.com.sg>

YASKAWA ELECTRIC (CHINA) CO., LTD.

12F, Carlton Bld., No.21 HuangHe Road, HuangPu District, Shanghai 200003, China
Phone 86-21-5385-2200 Fax 86-21-5385-3299
<http://www.yaskawa.com.cn>

YASKAWA ELECTRIC (CHINA) CO., LTD. BEIJING OFFICE

Room 1011, Tower W3 Oriental Plaza, No.1 East Chang An Ave.,
Dong Cheng District, Beijing 100738, China
Phone 86-10-8518-4086 Fax 86-10-8518-4082

YASKAWA ELECTRIC TAIWAN CORPORATION

9F, 16, Nanking E. Rd., Sec. 3, Taipei 104, Taiwan
Phone 886-2-2502-5003 Fax 886-2-2505-1280



YASKAWA ELECTRIC CORPORATION

In the event that the end user of this product is to be the military and said product is to be employed in any weapons systems or the manufacture thereof, the export will fall under the relevant regulations as stipulated in the Foreign Exchange and Foreign Trade Regulations. Therefore, be sure to follow all procedures and submit all relevant documentation according to any and all rules, regulations and laws that may apply.

Specifications are subject to change without notice for ongoing product modifications and improvements.

© 1999-2014 YASKAWA ELECTRIC CORPORATION. All rights reserved.

MANUAL NO. TOB-C718-4C

Published in Japan January 2014 99-3 0
13-6-9

한국 전파법에 관한 주의사항

韓国電波法に關連する注意事項

Precautions for Korean Radio Waves Act

针对韩国电波法的注意事项

사용자 안내문

기종별	사용자 안내문
A 급 기기 (업무용 방송 통신기 자재)	이 기기는 업무용 (A 급) 전자파 적합 기기로서 판매자 또는, 사용자는 이 점을 주의하시기 바라며, 가정외의 지역에서 사용하는 것을 목적으로 합니다.