



ACサーボドライブ Σ -IIシリーズ

取扱説明書

DeviceNet アプリケーションモジュール

形式 JUSP-NS300, JUSP-NS300-E

製品を安全にお使い頂くために、本書を必ずお読みください。
また、本書をお手元に保管していただくとともに、最終的に本製品をご使用になるユーザー様のお手元に確実に届けられるよう、お取り計らい願います。

AC Servo Drives Σ -II Series INSTRUCTIONS

DeviceNet Application Module

Type JUSP-NS300, JUSP-NS300-E

To properly use the product, read this manual thoroughly and retain for easy reference, inspection, and maintenance. Ensure the end user receives this manual.

Copyright © 2000 YASKAWA ELECTRIC CORPORATION

All rights reserved. No part of this publication may be reproduced, stored in a retrieval system, or transmitted, in any form, or by any means, mechanical, electronic, photocopying, recording, or otherwise, without the prior written permission of Yaskawa. No patent liability is assumed with respect to the use of the information contained herein. Moreover, because Yaskawa is constantly striving to improve its high-quality products, the information contained in this manual is subject to change without notice. Every precaution has been taken in the preparation of this manual. Nevertheless, Yaskawa assumes no responsibility for errors or omissions. Neither is any liability assumed for damages resulting from the use of the information contained in this publication.

INTRODUCTION

■ Manual Contents

This manual consists of Japanese Version and English Version.

- Japanese Version: Described on pages J-1 to J-31.
- English Version: Described on pages E-1 to E-30.

Use the Japanese Version or English Version as needed.

■ User Instructions

Use these instructions for the following jobs:

- Checking Σ -II Series SERVOPACK on delivery
- Installing Σ -II Series SERVOPACK
- Wiring Σ -II Series SERVOPACK
- Operating Σ -II Series SERVOPACK
- Inspecting and maintenance of Σ -II Series SERVOPACK

INSTRUCTIONS

Σ-II SERIES SGDH DeviceNet APPLICATION MODULE

SYMBOLS FOR SAFE OPERATION	E-4
NOTES FOR SAFE OPERATION	E-4
1 PARTS	E-8
2 CHECKING ON DELIVERY	E-9
2.1 Checking Items	E-9
2.2 Appearance and Nameplate	E-9
2.3 Type Designation	E-10
2.4 Mounting NS300 Module	E-10
3 INSTALLATION	E-13
3.1 Storage	E-13
3.2 Installation Sites	E-13
3.3 Orientation	E-14
3.4 Installation Precautions	E-14
4 WIRING	E-16
4.1 DeviceNet Connection Example	E-17
4.2 DeviceNet Communications Connection Example	E-17
4.3 DeviceNet Communications Connectors (CN6)	E-20
4.4 Precautions for Wiring DeviceNet Cables	E-20
4.5 Grounding	E-24
5 EDS FILE	E-25

6	OPERATION	E-25
6.1	Precautions at Test Run	E-25
6.2	Precautions at Operation	E-26
7	INSPECTION AND MAINTENANCE	E-27
8	MEASURES TO SATISFY THE EMC DIRECTIVE	E-28
8.1	DeviceNet Communication Cable	E-28
8.2	Fully Closed Encoder Cable	E-28
8.3	The Core on the Cable	E-28
8.4	Cable Clamp	E-29
8.5	Wiring Examples	E-30

Revision History

This instruction manual covers Σ -II Series SGDH DeviceNet* Application Module (hereinafter called NS300 Module), which is an application module to be connected to Σ -II series SGDH SERVOPACK for DeviceNet.

To properly use the NS300 Module, read this manual thoroughly and retain for easy reference for inspections and maintenance etc.

* DeviceNet is a trademark of ODVA (Open DeviceNet Vender Association, Inc.).

Reference materials are listed below:

Manual Titles	Manual No.
Σ -II Series SGM□H/SGDH User's Manual	SIEPS80000005
Σ -II Series SGDH DeviceNet Application Module User's Manual	SIE-C718-6
AC SERVOMOTOR INSTRUCTIONS	TOE-C231-2
Σ -II Series SGDH Instruction Manual	TOB-S800-32

SYMBOLS FOR SAFE OPERATION

In this manual, the NOTES FOR SAFE OPERATION are classified as “WARNING” or “CAUTION”. The following symbols are used.



Indicates a potentially hazardous situation which, if not avoided, could result in death or serious personal injury.



Indicates a potentially hazardous situation which, if not avoided, may result in minor or moderate personal injury and/or damage to the equipment.

In some instances, items described in  may also result in a serious accident. In either case, follow these important items.

NOTES FOR SAFE OPERATION

Read this manual thoroughly before installation, operation, maintenance or inspection of the AC Servo Drives.

■ CHECKING ON DELIVERY

 CAUTION	
<ul style="list-style-type: none">When SGD_H SERVOPACK is used with an NS300 Module mounted, the parameters are automatically set so that the NS300 Module can be operated from the first power ON. <p>For details of parameter setting methods, refer to Σ-II Series SGM□/SGD_H User's Manual (SIEPS80000005).</p>	<small>(Ref.No.) E-9</small>

■ STORAGE AND TRANSPORTATION

 CAUTION	
<ul style="list-style-type: none">If disinfectants or insecticides must be used to treat packing materials such as wooden frames, pallets, or plywood, the packing materials must be treated before the product is packaged, and methods other than fumigation must be used. <p>Example: Heat treatment, where materials are kiln-dried to a core temperature of 56°C for 30 minutes or more.</p> <p>If the electronic products, which include stand-alone products and products installed in machines, are packed with fumigated wooden materials, the electrical components may be greatly damaged by the gases or fumes resulting from the fumigation process. In particular, disinfectants containing halogen, which includes chlorine, fluorine, bromine, or iodine can contribute to the erosion of the capacitors.</p>	

■ INSTALLATION

 CAUTION	
<ul style="list-style-type: none">• Never use the equipment where it may be exposed to splashes of water, corrosive or flammable gases, or near flammable materials. <p>Failure to observe this caution may lead to electric shock or fire.</p>	<p>(Ref.No.) E-13</p>

■ WIRING

 WARNING	
<ul style="list-style-type: none">• SERVOPACK grounding must be in accordance with the national code and consistent with sound local practices. <p>Failure to observe this warning may lead to electric shock or fire.</p>	<p>(Ref.No.) E-16</p>

 CAUTION	
<ul style="list-style-type: none">• Do not connect three-phase power supply to SERVOPACK output terminals U, V, and W. <p>Failure to observe this caution may lead to personal injury or fire.</p> <ul style="list-style-type: none">• Securely tighten screws on the power supply and motor output terminals. <p>Failure to observe this caution may result in a fire.</p>	<p>(Ref.No.) E-16</p> <p>E-16</p>

■ OPERATION

 CAUTION	
<ul style="list-style-type: none">• To avoid inadvertent accidents, run the servomotor only in test run (without load). <p>Failure to observe this caution may result in personal injury.</p>	<p>(Ref.No.) E-25</p>
<ul style="list-style-type: none">• Before starting operation with a load connected, set up parameters suitable for the machine. <p>Starting operation without setting up parameters may lead to overrun failure.</p>	<p>E-25</p>
<ul style="list-style-type: none">• Before starting operation with a connected load, make sure emergency-stop procedures are in place. <p>Failure to observe this caution may result in personal injury.</p>	<p>E-25</p>
<ul style="list-style-type: none">• During operation, do not touch the SERVOPACK's heatsink. <p>Failure to observe this caution may result in burns.</p>	<p>E-26</p>

■ INSPECTION AND MAINTENANCE

WARNING

- | | |
|---|-----------|
| | (Ref.No.) |
| • Be sure to turn OFF power before inspection or maintenance.
Otherwise, electric shock may result. | E-27 |
| • Never open the terminal cover while power is ON, and never turn ON power when the terminal cover is open.
Otherwise, electric shock may result. | E-27 |
| • After turning OFF power, wait at least five minutes before servicing the product.
Otherwise, residual electric charges may result in electric shock. | E-27 |



CAUTION

- | | |
|--|-----------|
| | (Ref.No.) |
| • Never change wiring while power is ON.
Failure to observe this caution may result in electric shock or personal injury. | E-27 |

Note the following to ensure safe application.

- Some drawings in this manual are shown with the protective cover or shields removed, in order to describe the detail with more clarity. Make sure all covers and shields are replaced before operating this product.
- Some drawings in this manual are shown as typical example and may differ from the shipped product.
- This manual may be modified when necessary because of improvement of the product, modification or changes in specifications.
Such modification is made as a revision by renewing the manual No.
- To order a copy of this manual, if your copy has been damaged or lost, contact your YASKAWA representative listed on the last page stating the manual No. on the front cover.
- YASKAWA is not responsible for accidents or damages due to any modification of the product made by the user since that will void our guarantee.

WARNING LABEL

	危険 通電中及び電源オフ後、5分間端子部に触るな！ 感電のおそれあり
WARNING	Disconnect all power and wait 5 min. before servicing. May cause electric shock.
	注意 通電中はヒートシンクに触るな！ 火傷の恐れあり
CAUTION	Do not touch heat sink when power is ON. May cause burn.
	必ずアース線を接続せよ Use proper grounding techniques.

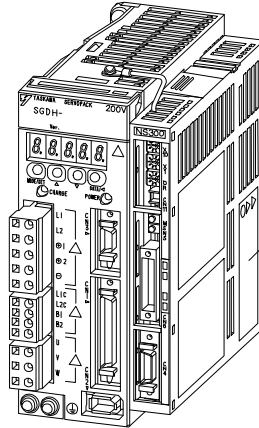

SERVOPACK warning label position

SERVOPACK Warning Label and Grounding Mark Position

1 PARTS

The NS300 Module parts names are as follows:

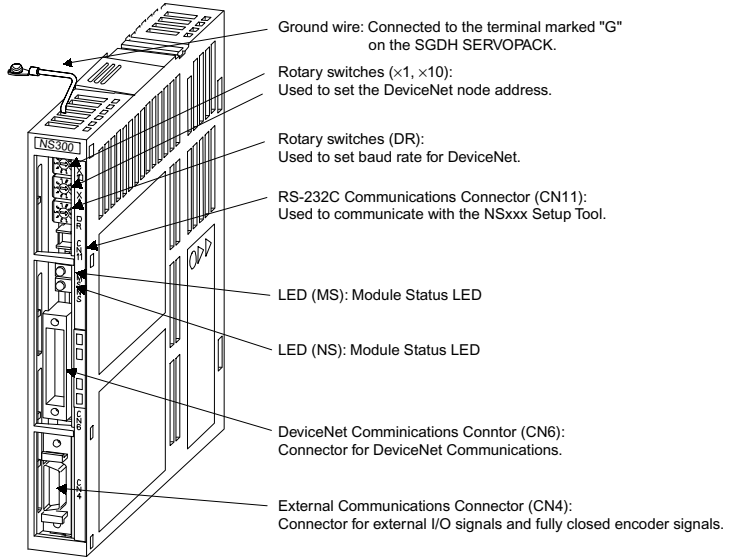

2 CHECKING ON DELIVERY

⚠ CAUTION

- When SGD_H SERVOPACK is used with an NS300 Module mounted, the parameters are automatically set so that the application module can be operated from the first power ON.

For details of parameter setting methods, refer to Σ -II Series SGM□/SGD_H User's Manual (SIEPS8000005).

2.1 Checking Items

When Σ -II Series products are delivered, check the following items:

Check Items	Remarks
Check if the delivered products are the ones you ordered.	Check the types marked on the nameplates of the application module.
Check for damage.	Check the overall appearance, and check for damage or scratches resulting from transportation.
Check if SERVOPACK is the type applicable for application module?	Check the nameplate of SERVOPACK. SERVOPACK Type SGD _H -□□□E-□ ① ② “SGD _H ” in ①, and “E” in ②

If any of the above items are faulty or incorrect, contact the dealer from which you purchased the products or your nearest local sales representative.

2.2 Appearance and Nameplate

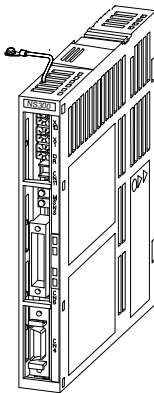

NS300 Module

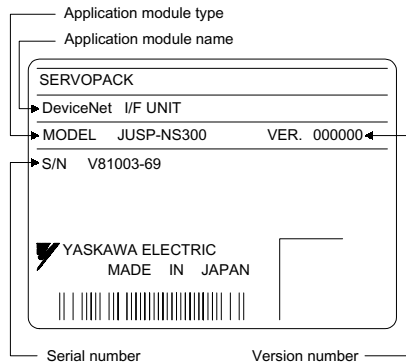

2.3 Type Designation

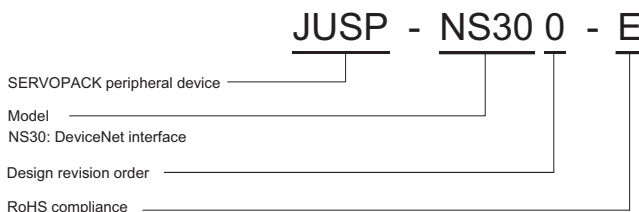

2.4 Mounting NS300 Module

Mount an NS300 Module on a SGD_H SERVOPACK in the following manner. Provide the screws for connecting ground wire as shown below.

Mounting Method	SERVOPACK Type	Screw	Remarks
Base mounted	SGDH-A3 to 02BE SGDH-A3 to 10AE	M3×10 round head screws (with spring washer and plain washer)	Attachments.
	SGDH-15 to 50AE SGDH-05 to 50DE	M4×10 round head screws (with spring washer and plain washer)	Attachments.
	SGDH-60 to 1EAE SGDH-60 to 1EDE	M4×8 round head screws (with spring washer and plain washer)	Use the screw of the front panel.
Rack mounted	SGDH-A3 to 02BE-R SGDH-A3 to 50AE-R SGDH-05 to 50DE-R	M4×6 round head screws (with spring washer and plain washer)	Attachments. Note: Make sure that spring washers and plain washers are used for mounting. (Otherwise, the screw for connecting ground wire sticks out from the other side of the flange, and the SERVOPACK cannot be mounted properly.)
Duct ventilated	SGDH-60 to 1EAE-P SGDH-60 to 1EDE-P	M4×8 round head screws (with spring washer and plain washer)	Use the screw of the front panel.

1. Remove the connector cover mounted on CN10 of SERVOPACK.

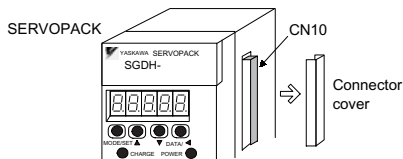

2. Mount an NS300 Module.

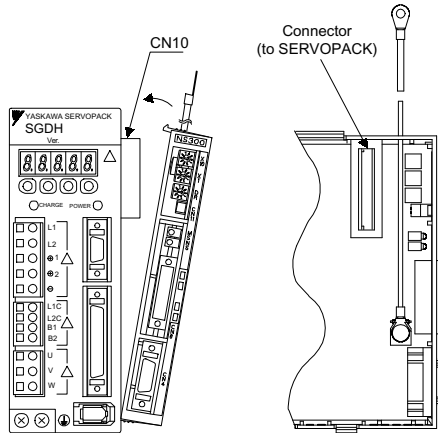

3. For grounding, connect a ground wire of the application module to the marked "G" on the SERVOPACK.

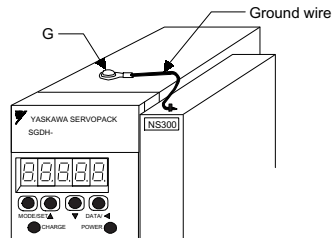

For SERVOPACK (30 W to 5.0 kW)

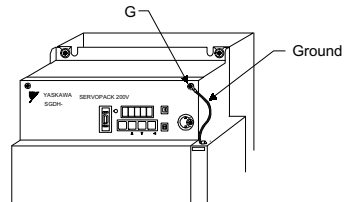

For SERVOPACK (6.0 kW to 7.5 kW)

The appearance of SERVOPACK with application module properly mounted is shown below.

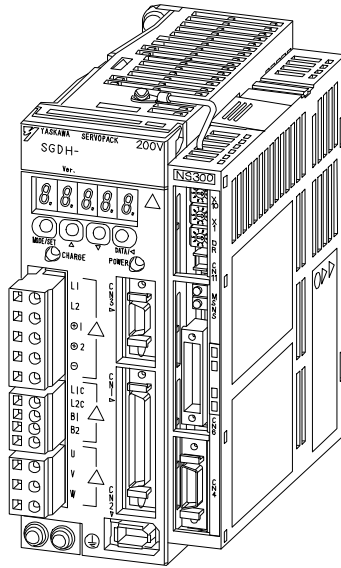

3 INSTALLATION

Σ -II Series SGDH SERVOPACK is a base-mount type servo controller. Incorrect installation will cause problems. Always observe the installation instructions described below.

⚠ CAUTION

- Never use the equipment where it may be exposed to splashes of water, corrosive or flammable gases, or near flammable materials.

Failure to observe this caution may lead to electric shock or fire.

3.1 Storage

When the SERVOPACK is to be stored with the power cable disconnected, store it in the following temperature range:

Between -20°C to $+85^{\circ}\text{C}$

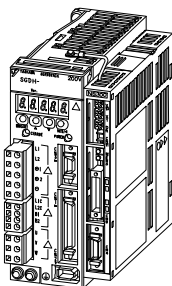

Σ -II Series
SGDH SERVOPACK with NS300 Module mounted

3.2 Installation Sites

For installation sites, use proper care with the following notes.

Situation	Notes on Installation
When installed in a control panel	Design the control panel size, unit layout, and cooling method so that the temperature around the periphery of the SERVOPACK does not exceed 55°C .
When installed near a heating unit	Suppress radiation heat from the heating unit and a temperature rise caused by convection so that the temperature around the periphery of the SERVOPACK does not exceed 55°C .
When installed near a source of vibration	Install a vibration isolator underneath the SERVOPACK to prevent it from receiving vibration.
When installed in a place receiving corrosive gases	Corrosive gases do not immediately affect the SERVOPACK but will eventually cause contactor-related devices to malfunction. Take appropriate action to protect against corrosive gases.
Others	Avoid installation in a hot and humid place or where excessive dust or iron powder is present in the air. Install in a place where the altitude is 1000 m or less.

3.3 Orientation

Install the SERVOPACK perpendicular to the wall as shown in the figure below.

The SERVOPACK must be orientated as shown in the figure.

Firmly secure the SERVOPACK through two to four mounting holes depending on the SERVOPACK capacity.

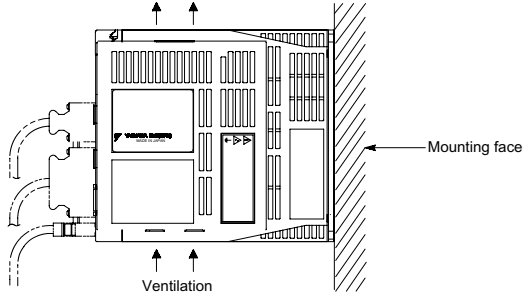

3.4 Installation Precautions

When installing multiple SERVOPACKS side by side in a control panel, observe the following installation method:

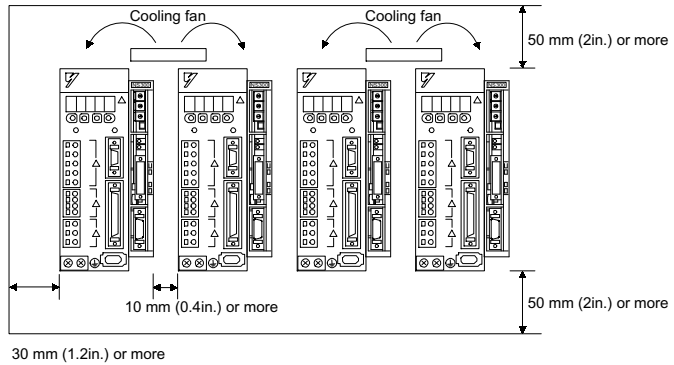

■ Front Panel

Install SERVOPACK perpendicular to the wall so that the front panel (digital operator mounted face) faces outward.

■ Cooling

Provide sufficient space around each SERVOPACK to allow cooling by fan and natural convection.

■ Where mounted side by side

When installing SERVOPACKs side by side, provide at least 10mm (0.4in.) space between them and at least 50mm (2in.) space above and below them as shown in the figure above. Install cooling fans above the SERVOPACKs to prevent the temperature around each SERVOPACK from increasing excessively and also to maintain the temperature inside the control panel evenly.

■ Environments in Control Panel

Maintain the following conditions inside the control panel:

- Ambient temperature for SERVOPACK: 0 to 55°C
- Humidity: 90%RH or less
- Vibration: 4.9 m/s²
- Condensation and freezing: None
- Ambient temperature to ensure long-term reliability: 45°C or less
- Altitude of 1000 m max.

4 WIRING

This section shows a standard example for connecting Σ -II series products to peripheral devices and briefly explains how to connect each peripheral device.

 WARNING
--

- | |
|---|
| <ul style="list-style-type: none">• SERVOPACK grounding must be in accordance with the national code and consistent with sound local practices. |
|---|

Failure to observe this warning may lead to electric shock or fire.

 CAUTION
--

- | |
|---|
| <ul style="list-style-type: none">• Do not connect three-phase power supply to SERVOPACK output terminals U, V and W. |
|---|

Failure to observe this caution may lead to personal injury or fire.
--

- | |
|---|
| <ul style="list-style-type: none">• Securely tighten screws on the power supply and motor output terminals. |
|---|

Failure to observe this caution may result in a fire.

For the following wiring, refer to Σ -II series SGM□H/SGDH User's Manual (SIEPS8000005) and Σ -II series SGDH DeviceNet Application Module User's Manual (SIE-C718-6).

- Main circuit wiring
- I/O signal wiring
- Encoder wiring
- Example of connections

4.1 DeviceNet Connection Example

An example of DeviceNet connection is shown below.

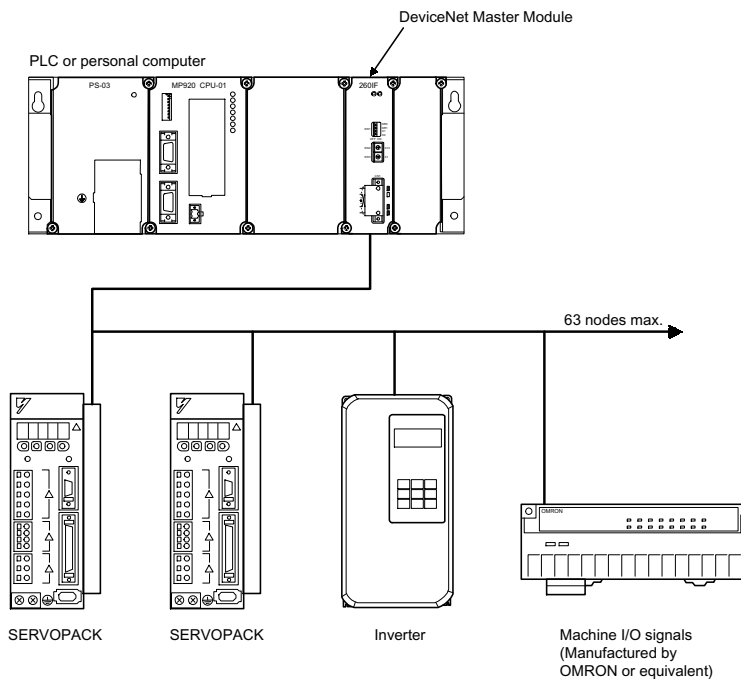

4.2 DeviceNet Communications Connection Example

The following diagram shows an example of connections between a host controller and a NS300 Module (CN6) using DeviceNet communications cables.

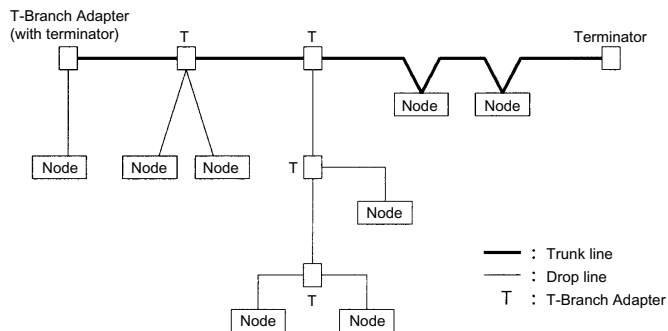

■ Configuration Elements

The network is configured from the following elements.

Nodes

A node is either a slave that connects to an NS300 Module or similar Module, or the Master that manages the I/O of the slaves. There are no restrictions on the location of the Master or slaves. Any node in the figure above can be the Master or a slave.

Trunk Line and Drop Lines

A cable with a terminator on each end is a trunk line. Any cable branching from the trunk line is a drop line.

Connection Methods

A node is connected using the T-branch method or multi-drop method. A T-Branch Adapter is used to connect a node with the T-branch method. A node is directly connected to the trunk line or a drop line with the multi-drop method. Both T-branch and multi-drop methods can be used together in the same network, as shown in the figure above.

Terminator

Both ends of the trunk line must connect to terminating resistance to decrease signal reflection and ensure stable network communications.

Communications Power Supply

The communications connector of each node must be provided with a communications power supply through the communications cable for DeviceNet communications.

IMPORTANT

1. The communications cable must be a special DeviceNet cable.
 2. Both ends of the trunk line must connect to a terminator.
 3. Only DeviceNet devices can be connected to the network. Do not connect any other devices, such as a lightning arrester.
-

■ Branching from the Trunk Line

There are three methods that can be used to branch from the trunk line.

Single Branching

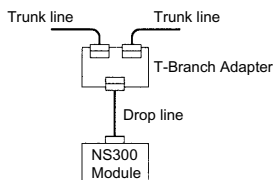

Branching to Three Drop Lines

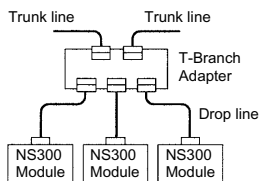

Direct Node Connection

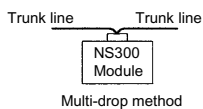

■ Branching from Drop Lines

There are three methods that can be used to branch from drop lines.

Single Branching

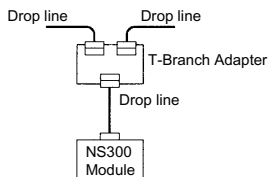

Branching to Three Drop Lines

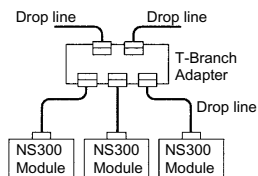

Direct Node Connection

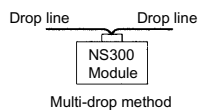

4.3 DeviceNet Communications Connectors (CN6)

The terminal layout and specifications of the CN6 connectors are shown below.

■ Connector Specifications

The following table shows the connector specifications. These connectors are metal plated with a flange attached.

Name	Model	Manufacturer
Connector	MSTB2.5/5-STF-5.08AU	PHOENIX CONTACT
Case		

■ Connector Pin Arrangement

The connector pin arrangement is as shown below.

Pin No. and Code	Symbol	Detail
1	0 (24 V)	0 V external communications power supply
2	CAN L	CAN bus line dominant L
3	SHIELD	Connect to the wire mesh around the cable.
4	CAN H	CAN bus line dominant H
5	24 V	24 V external communications power supply

4.4 Precautions for Wiring DeviceNet Cables

Observe the following precautions when wiring DeviceNet cables.

■ Maximum Network Length

The maximum network length is either the line length between two nodes located farthest from each other or the line length between the terminators on the ends of the trunk line, whichever is longer.

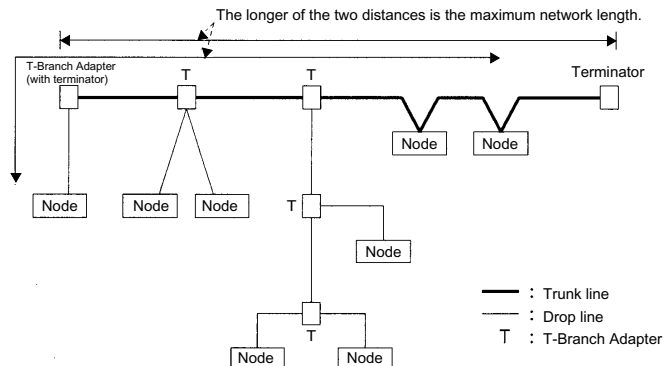

Special DeviceNet cables can be either thick cables or thin cables. The characteristics of each type are given in the following table.

Item	Cable Type	
	Thick Cable	Thin Cable
Signal decay	Slight	Considerable
Communications distance	Long distance	Short distance
Characteristics	Rigid (difficult to bend)	Pliable (bends easily)

The maximum network length is determined by the type of cable, as shown in the following table.

Baud rate (Kbps)	Maximum network length (m)	
	Thick cable	Thin cable
500	100	100
250	250	100
125	500	100



Using Thick Cable and Thin Cable Together

The line connecting two nodes located farthest from each other can use both thick and thin cables provided that the length of each cable satisfies the conditions in the following table.

Baud Rate (Kbps)	Maximum Network Length (m)
500	$L_{\text{THICK}} + L_{\text{THIN}} \leq 100$
250	$L_{\text{THICK}} + 2.5 \times L_{\text{THIN}} \leq 250$
125	$L_{\text{THICK}} + 5.0 \times L_{\text{THIN}} \leq 500$

Note: L_{THICK} : Thick cable length L_{THIN} : Thin cable length

■ Drop Line Length

The drop line length is the line length between a branch point on the trunk line to the farthest node that is located on the drop line. The maximum drop line length is 6 m. A drop line can be branched out into other drop lines.

■ Total Drop Line Length

The total drop line length is a total of all drop line lengths.

Length Limits

The total drop line length must be within the allowable range and even then, each drop line must be 6 m or less.

The allowable range of total drop line length varies with the baud rate as shown in the following table.

Baud Rate (Kbps)	Total Drop Line Length (m)
500	39 max.
250	78 max.
125	156 max.

The following example is for a baud rate of 500 Kbps.

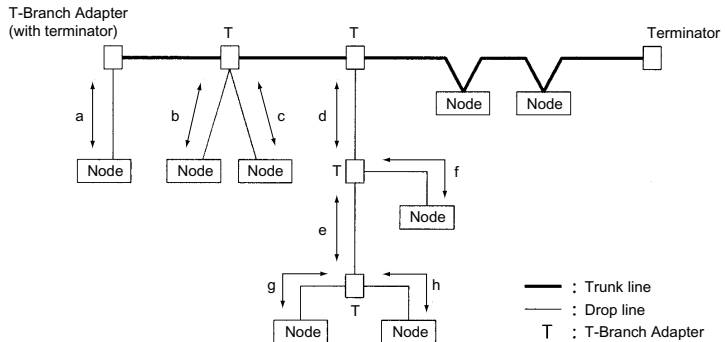

The above example must satisfy the following conditions.

- $a \leq 6$ m
- $b \leq 6$ m
- $c \leq 6$ m
- $d \leq 6$ m
- $d+f \leq 6$ m
- $d+e+g \leq 6$ m
- $d+e+h \leq 6$ m

The total drop line length must satisfy the following condition.

- Total drop line length = $a+b+c+d+e+f+g+h \leq 39$ m

■ Basic Precautions

Basic precautions are as follows:

- The communications power supply to the network must be 24 VDC.
- The communications power supply must have a sufficient margin in the capacity.
- Connect the communications power supply to the trunk line.
- If many nodes are provided with power from a single power supply, locate the power supply as close as possible to the middle of the trunk line.
- The allowable current flow in a thick cable is 8 A and that in a thin cable is 3 A.
- The power supply capacity for a drop line varies with the drop line length. The longer a drop line is, the lower the maximum current capacity of the drop line will be regardless of the thickness of the drop line. Obtain the allowable current (I) of the drop line (i.e., the allowable current consumption of the drop line and devices connected to it) from the following equation

$$I = 4.57/L$$

I: Allowable current (A)
L: Drop line length (m)

- If only the communications power supply is turned OFF while the network is operating, errors may occur in the nodes that are communicating at that time.

■ Location of Power Supply

The following two types of configuration are possible for the location of the power supply.

Nodes on Both Sides of the Power Supply

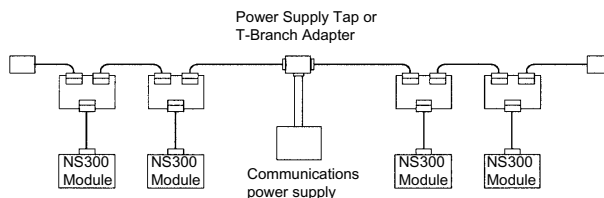

Nodes on One Side of the Power Supply

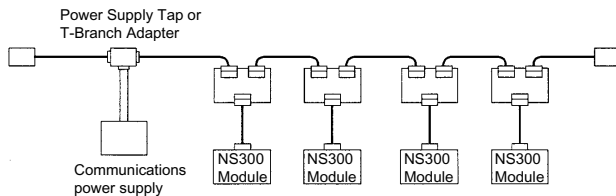

Note: The “Nodes on Both Sides of the Power Supply” method is recommended if a single power supply is connected to many nodes.

4.5 Grounding

As shown below, connect the shield wire of the cable to the FG terminal of the communications power supply and ground the shield wire to a resistance of 100Ω or less.

■ Power Supply with Single-point Ground

T-Branch Adapter or Power Supply Tap

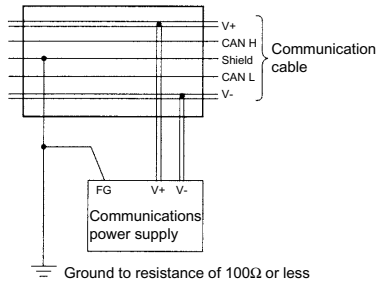

■ Power Supply without Ground

Power Supply Tap

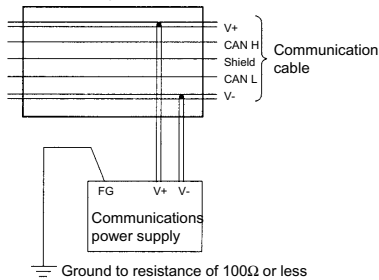

If more than one communications power supply is used, ground only the power supply that is located closest to the middle of the network through the shield wire. Do not ground the power supply through the shield wire at any other point. If more than one communications power supply is connected to the network, connect them using a Power Supply Tap each.

IMPORTANT

1. Power supplies are not counted as nodes.
 2. Ground the network to a resistance of 100Ω or less.
 3. Do not ground the network together with servodrivers or inverters.
 4. Do not ground the network through the shield wire at more than one point; ground at a single point only.
-

5 EDS File

An EDS file is required when using DeviceNet setting tool to make settings or monitor the NS300 Module. After installing the EDS file in the setting tool, setting and monitoring can be done. The EDS file differs in accordance with the product used.

Product Model	ESD File Name
JUSP-NS300	NS300.eds
JUSP-NS300-E	NS300E.eds

Download the EDS File from the ODVA's homepage or Yaskawa's e-mechatronics site (<http://www.e-mechatronics.com/>).

6 OPERATION

This section provides precautions at test run and operation. For instructions on test run and operation, refer to Σ -II series SGM□□H/SGDH User's Manual (SIEPS80000005) and Σ -II series SGDH DeviceNet Application Module User's Manual (SIE-C718-6).

6.1 Precautions at Test Run

 CAUTION
<ul style="list-style-type: none"> • To avoid inadvertent accidents, run the servomotor only in test run (without load). Failure to observe this caution may result in personal injury. • Before starting operation with a load connected, set up parameters suitable for the machine. Starting operation without setting up parameters may lead to overrun failure. • Before starting operation with a connected load, make sure emergency-stop procedures are in place. Failure to observe this caution may result in personal injury.

■ Conducting Test Run for Servomotor without Load

When servomotor is operated without load, set the load inertia (parameter Pn103) to 0. (Factory setting is 0)

When servomotor is rotated without load, if the value has been set to other than 0, the servomotor may oscillate.

To avoid this, make sure to set the load inertia to 0 and then servo ON.

■ Conducting Test Run with Servomotor Connected to Machine

SERVOPACK initial parameters setting is performed assuming normal operation conditions. Before test run, set up parameters suitable for the machine.

Failure to set up the parameters initial setting may result in machine overrun or breakdown.

As for the setting procedures and methods, refer to Σ -II Series SGM□□H/SGDH User's Manual (SIEPS80000005).

■ Check Item during Test Run

The following items should be checked during test run.

- Unusual vibration
- Abnormal noise
- Excessive temperature rise

6.2 Precautions at Operation



CAUTION

- During operation, do not touch the SERVOPACK's heatsink.
Failure to observe this caution may result in burns.

7 INSPECTION AND MAINTENANCE

This section describes the basic inspections and maintenance. If any failure occurs on SERVOPACK, refer to Σ -II Series SGM□H/SGDH User's Manual 10.1 Troubleshooting (SIEPS80000005) and Σ -II Series SGDH DeviceNet Application Module User's Manual (SIE-C718-6). Contact your Yaskawa representative if the problem cannot be solved by the procedures described.



WARNING

- Be sure to turn OFF power before inspection or maintenance.
Otherwise, electric shock may result.
- Never open the terminal cover while power is ON, and never turn ON power when the terminal cover is open.
Otherwise, electric shock may result.
- After turning OFF power, wait at least five minutes before servicing the product.
Otherwise, residual electric charges may result in electric shock.



CAUTION

- Never change wiring while power is ON.
Failure to observe this caution may result in electric shock or personal injury.

8 MEASURES TO SATISFY THE EMC DIRECTIVE

This section describes the measures required for the NS300 Module to conform to EMC Directive (EN50081-2, EN50082-2).

8.1 DeviceNet Communication Cable

For DeviceNet (CN6 connector), use the cable for special use.
For max. cable length, refer to “4.4 Precautions for Wiring DeviceNet Cables”
Use the special DeviceNet cable.

8.2 Fully Closed Encoder Cable

For fully closed encoder (CN4) connector, use the following connector.
Use the twisted pair shielded cable.

Connector: 54306-2011 (Made by Molex Japan Co., Ltd.)

Connector case: 54331-0201 (Made by Molex Japan Co., Ltd.)

8.3 The Core on the Cable

Attach the core on the cable as shown below:

Model	ESD-SR-25	ESD-SR-250 (RoHS compliance)
Quantity	1	
Turn	2	
Manufacturer	Tokin.Corp.	

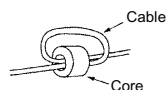

Cable line and the line position where the core are attached are shown below.

Cable Name	Mounting Position of Core
DeviceNet Communication Cable	Near the host controller and SERVOPACK
Fully Closed Encoder Cable	Near the SERVOPACK

Note: For details on the SERVOPACK core and the line filter, refer to Σ -II series SGDH Instruction Manual (TOB-S800-32).

8.4 Cable Clamp

Fix and ground the cable shield using a piece of conductive metal.

<Example of Cable Clamp>

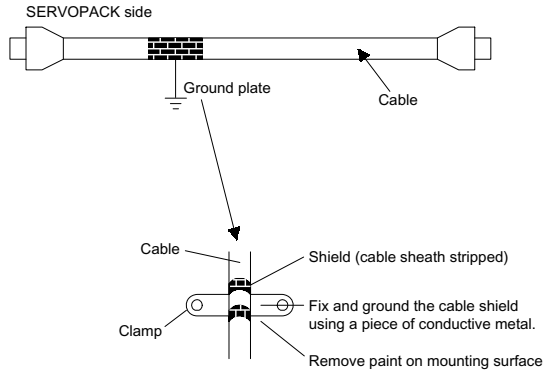

8.5 Wiring Examples

The following diagrams show the wiring example. Before wiring, turn OFF the power ON/OFF switch and post a notice of “No Conduction”. Only an electrical expert can perform the wiring. The noise filter and the core are shown in the diagram.

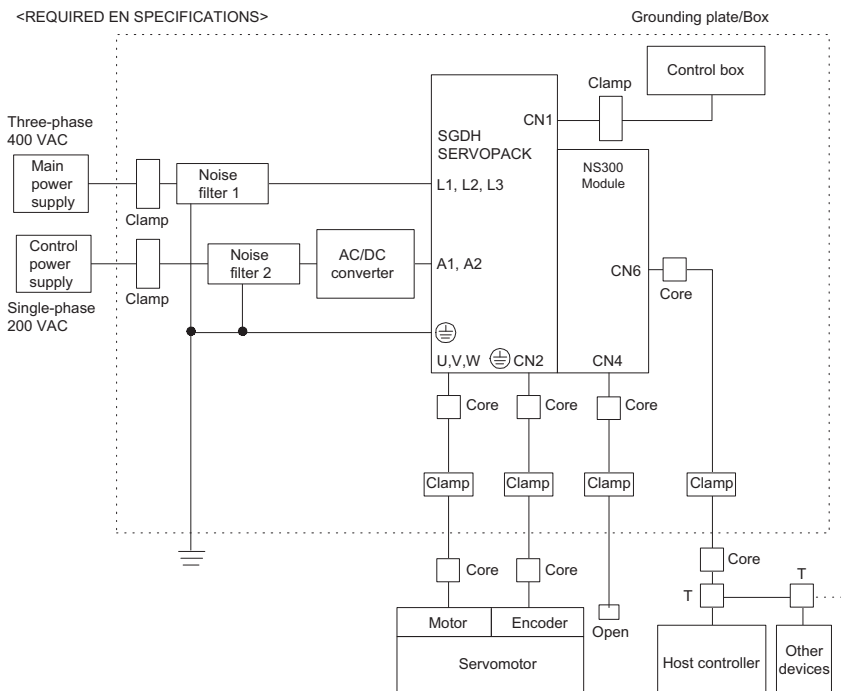

- Note:
1. Clamp: Secure cable shields and ground for conductive metal parts.
 2. Make sure that the grounding plate are securely connected to the grounding.
 3. Remove the paint from the grounding plate to insure a good Earth connection for filter, SERVOPACK, clamp, etc.

Revision History

The revision dates and numbers of the revised manuals are given on the bottom of the back cover.

MANUAL NO. TOB-C718-6

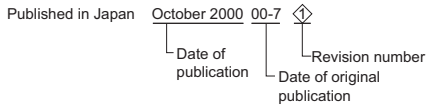

Date of Publication	Rev. No.	Section	Revised Content
March 2014	①	Back cover	Revision: Address
June 2013	①	Back cover	Revision: Address
November 2010	②	Front cover	Revision: Format
		Back cover	Revision: Address, format
August 2008	③	Back cover	Revision: Address
December 2007	④	Preface	Addition: PL on fumigation
		Chapter 5	Addition: Description of EDS file
		Back cover	Revision: Address
December 2006	⑤	All chapters	Revision: Unit changed to module, Interface unit changed to application module.
		Chapter 2	Addition: RoHS-compliant model
July 2005	⑥	All chapters	Slightly revised
May 2003	④	All chapters	Slightly revised
October 2002	③	All chapters	Slightly revised
August 2001	②	All chapters	Slightly revised
October 2000	①	All chapters	Slightly revised
July 2000	-	-	First edition

AC Servo Drives

Σ -II Series

INSTRUCTIONS

DeviceNet Application Module

IRUMA BUSINESS CENTER (SOLUTION CENTER)

480, Kamifujiisawa, Inuma, Saitama 358-8555, Japan
Phone 81-4-2962-5151 Fax 81-4-2962-6138
<http://www.yaskawa.co.jp>

YASKAWA AMERICA, INC.

2121 Norman Drive South, Waukegan, IL 60085, U.S.A.
Phone 1-800-YASKAWA (927-5292) or 1-847-887-7000 Fax 1-847-887-7310
<http://www.yaskawa.com>

YASKAWA ELÉTRICO DO BRASIL LTDA.

Avenida Piraporinha 777, Diadema, São Paulo, 09950-000, Brasil
Phone 55-11-3585-1100 Fax 55-11-3585-1187
<http://www.yaskawa.com.br>

YASKAWA EUROPE GmbH

Hauptstraße 185, Eschborn 65760, Germany
Phone 49-6196-569-300 Fax 49-6196-569-398
<http://www.yaskawa.eu.com>

YASKAWA ELECTRIC KOREA CORPORATION

9F, Kyobo Securities Bldg, 26-4, Yeouido-dong, Yeongdeungpo-gu, Seoul, 150-737, Korea
Phone 82-2-784-7844 Fax 82-2-784-8495
<http://www.yaskawa.co.kr>

YASKAWA ELECTRIC (SINGAPORE) PTE. LTD.

151 Lorong Chuan, #04-02A, New Tech Park 556741, Singapore
Phone 65-6282-3003 Fax 65-6289-3003
<http://www.yaskawa.com.sg>

YASKAWA ELECTRIC (CHINA) CO., LTD.

12F, Carlton Bld., No.21 HuangHe Road, HuangPu District, Shanghai 200003, China
Phone 86-21-5385-2200 Fax 86-21-5385-3299
<http://www.yaskawa.com.cn>

YASKAWA ELECTRIC (CHINA) CO., LTD. BEIJING OFFICE

Room 1011, Tower W3 Oriental Plaza, No.1 East Chang An Ave.,
Dong Cheng District, Beijing 100738, China
Phone 86-10-8518-4086 Fax 86-10-8518-4082

YASKAWA ELECTRIC TAIWAN CORPORATION

9F, 16, Nanking E. Rd., Sec. 3, Taipei 104, Taiwan
Phone 886-2-2502-5003 Fax 886-2-2505-1280



YASKAWA ELECTRIC CORPORATION

In the event that the end user of this product is to be the military and said product is to be employed in any weapons systems or the manufacture thereof, the export will fall under the relevant regulations as stipulated in the Foreign Exchange and Foreign Trade Regulations. Therefore, be sure to follow all procedures and submit all relevant documentation according to any and all rules, regulations and laws that may apply.

Specifications are subject to change without notice for ongoing product modifications and improvements.

© 2000-2014 YASKAWA ELECTRIC CORPORATION. All rights reserved.

MANUAL NO. TOB-C718-6C

Published in Japan March 2014 00-7 0
13-6-9